

QNAP

Turbo vNAS The Golden Cloud Series TVS-x63+ Series

- Supports high-speed 10GbE network and extensive features for cost-conscious applications
- Hardware-accelerated encryption engine for efficient cryptographic performance exceeding 600MB/s
- Use the vNAS as a PC with exclusive QvPC Technology
- Designed for file management, sharing and backup of business data with LUN backup support
- VMware®, Microsoft® Hyper-V, Citrix®, and Microsoft® VDI compatible

4K2K UHD

QvPC
Technology



Use the NAS as a PC

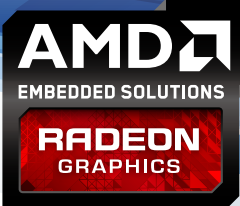

TVS-863+



- 1 x 10GbE Ethernet Port
- 8GB DDR3L-1600 RAM



Built-in
10GbE card

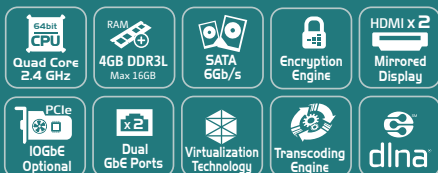

TVS-463

TVS-663

TVS-863

4th

Turbo vNAS The 4th Generation Enhanced with the QvPC Technology

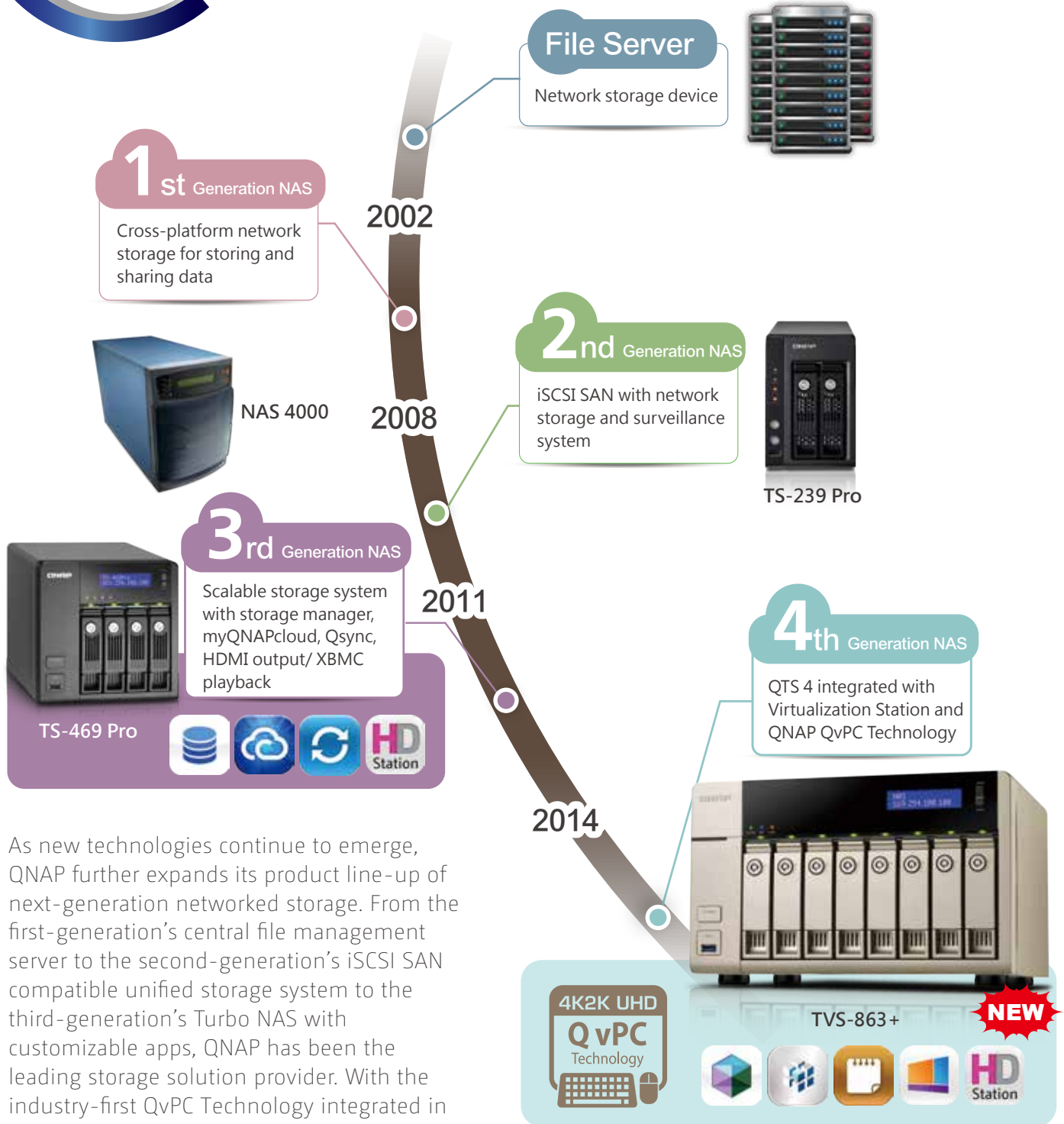

As new technologies continue to emerge, QNAP further expands its product line-up of next-generation networked storage. From the first-generation's central file management server to the second-generation's iSCSI SAN compatible unified storage system to the third-generation's Turbo NAS with customizable apps, QNAP has been the leading storage solution provider. With the industry-first QvPC Technology integrated in the fourth-generation NAS, our Turbo vNAS series are the world's first NAS that can be transformed into a cost-effective PC substitute for business applications. The TVS-x63+ series is built on AMD quad-core 2.4GHz processor and integrated with QvPC technology.

The Evolution of NAS

Table of Contents

10GbE-ready Turbo vNAS for SMBs	01
Virtualization Station	05
QvPC Technology	09
Unified Storage Management	15
File Storage, Management and Sharing (File Station)	19
Q'center CMS (Central Management System)	23
QTS 4.1.2 OS	25
Mobile Apps & Utilities.....	41
Business Solutions.....	43
App Center & Development Platform	57
Hardware Specifications	61
Software Specifications	62

10GbE-ready Turbo vNAS for SMBs

Affordable, Reliable and Scalable NAS Solution

Adorned with a box in gold color, the sophisticated TVS-x63+ series, featuring the easy-to-use QTS operating system, is a powerful, reliable, secure and scalable NAS solution designed for mission-critical and intensive business applications and to meet fast growing data storage needs. The Turbo vNAS supports 10GbE via PCI-E network expansion and delivers high performance with persistent throughput, providing a comprehensive storage solution for SMBs to build a reliable private cloud.

- › 10GbE-ready, highly-efficient storage solution for HD video editing and sharing
- › Enhanced data security with a high-performance hardware-accelerated encryption engine with AES 256-bit full NAS volume encryption and anti-virus
- › Use the TVS-863 as a PC with exclusive QvPC Technology and 4K display support
- › Run multiple Windows/Linux/Android-based virtual machines with the Virtualization Station
- › Manage, share, and back up business data with Real-time Remote Replication (RTRR)
- › NAS and iSCSI-SAN unified storage solution for server virtualization
- › Supports VMware®, Citrix®, and Microsoft® Hyper-V and advanced virtualization features
- › Transcode 1080p videos on-the-fly or offline with QNAP's unique transcoding technology and hardware transcoding engine
- › Expand the total raw storage capacity up to 192TB with the economical UX-800P expansion enclosures



“NAS is a great application for the AMD G-Series SoC, taking advantage of the strong compute, low-energy consumption, and integrated GPU for display and acceleration.”, said Scott Aylor, corporate vice president and general manager, AMD Embedded Solutions.



High performance & efficiency

The TVS-x63+ series is equipped with the energy-efficient 64-bit AMD® quad-core 2.4 GHz processor with 16/8/4GB DDR3L-1600 RAM options (upgradable to 16GB), SATA 6Gb/s, and 2 Gigabit LAN ports (expandable to max. 4 x GbE ports or 2 x GbE + 2 x 10GbE ports) for lightning-fast multi-tasking. The TVS-863+ is a powerful NAS that delivers up to 448MB/s read & write speeds with 4 x GbE port configuration, and up to 1,432MB/s with 10GbE configuration. The TVS-863+'s hardware-accelerated encryption engine provides unmatched encryption performance in its class, up to 691MB/s with AES-256 bit full NAS volume encryption, boosting system performance & security while ensuring the safety of sensitive business data stored in the TVS-863+. The next-gen AMD Radeon™ HD graphics provides hardware-accelerated transcoding performance and dual HDMI outputs with brilliant high-definition multimedia content playback. When installed with the latest Wi-Fi 802.11ac USB network adapter, the TVS-863+ can offer remarkably high speeds for transferring large amount of files and streaming bandwidth-consuming multimedia.

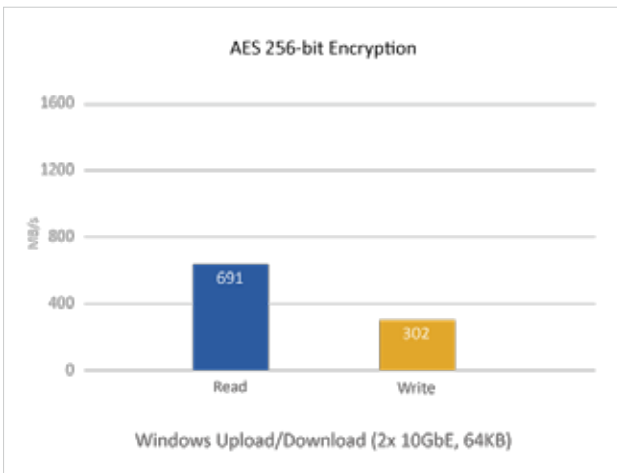

Quad-core 2.4 GHz



10GbE ready

The TVS-863+ offers 2 inbuilt Gigabit Ethernet ports & 1 pre-installed 10GbE PCI-E NIC (single port), supporting 10 Gigabit high speed network. The 10GbE-ready TVS-863+ delivers fast data throughput. Coupled with its large storage capacity potential, the TVS-863+ is perfect for data centers to store big data and excel in fast data transmission, and for 10GbE home lab environment for technical professionals.

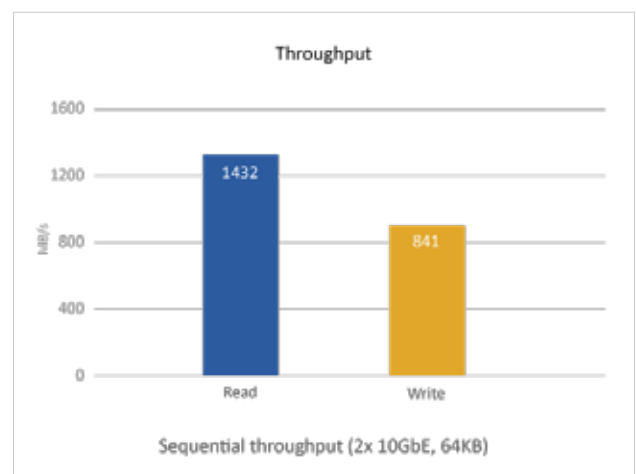
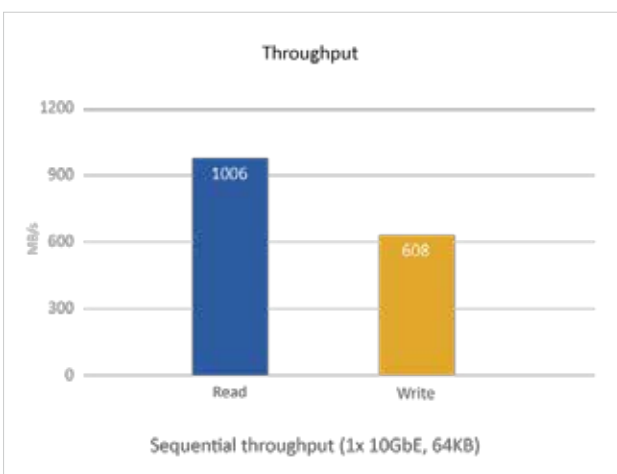

Test Environment :

NAS :

- OS : QTS 4.1.2

- Volume type : RAID 5; 4 x Plextor PX-256M5Pro SSD

- Network environment : direct connection between NAS and PC, 1GbE LAN (MTU 1500); 10GbE with QNAP LAN-10G2T-D dual-port PCIe NIC (MTU 9000)

Client PCs :

- Intel(R) Core(TM) i7-4770 3.40GHz CPU; DDR3 1600Hz 16GB; WD 1TB WD10EZX; Intel Gigabit CT (MTU 1500); 10GbE with QNAP LAN-10G2T-D dual-port PCIe NIC (MTU 9000); Windows® 7 Professional 64bit SP1

- IOMeter configuration : Transferring 8GB file continuously to/from 4/2 PCs for 3 minutes. Block size : 64KB for SMB2.0 (Throughput)

10GbE-ready Turbo vNAS for SMBs

▪ High-quality construction and informative LCD display

The TVS-x63+ series is adorned with a box in gold color, offering an exceptional choice with impressive sophistication. Built with metal frame and parts, the sleek and sturdy TVS-863+ also features a newly-crafted heat sink that can exhaust excessive heat with its passive cooling. The LCD display panel on the TVS-x63+ provides quick system information making system management even easier.

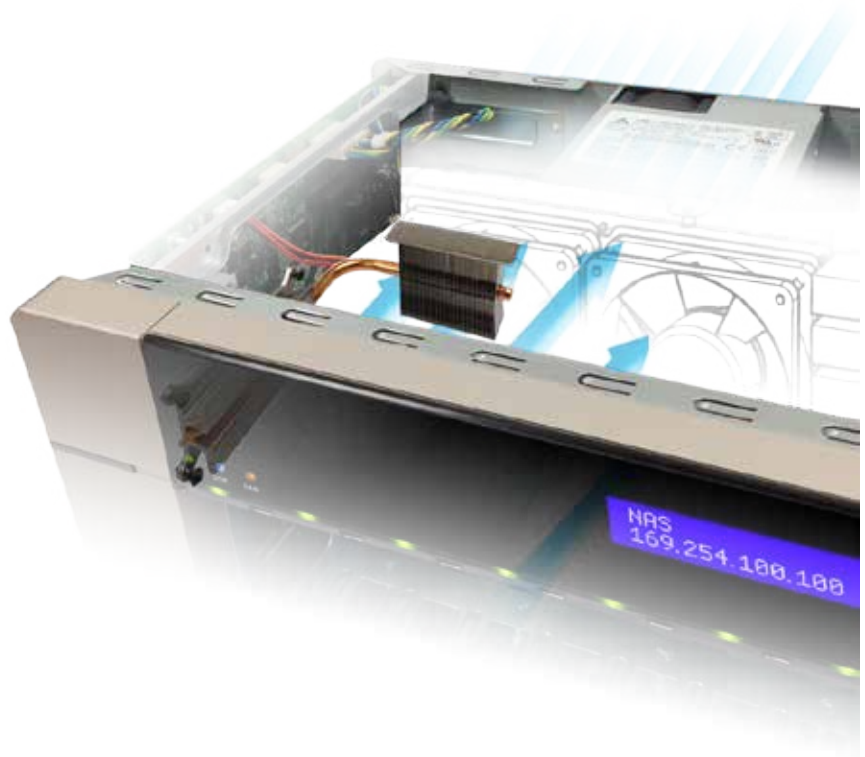

▪ Eco-friendly design

The TVS-x63+ series provides high performance with minimal power requirements and reduced heat generation with the low-voltage DDR3L RAM. Other eco-friendly designs include scheduled power on/off, hard disk standby mode, S3 sleep mode, and Wake on LAN.

Power Consumption

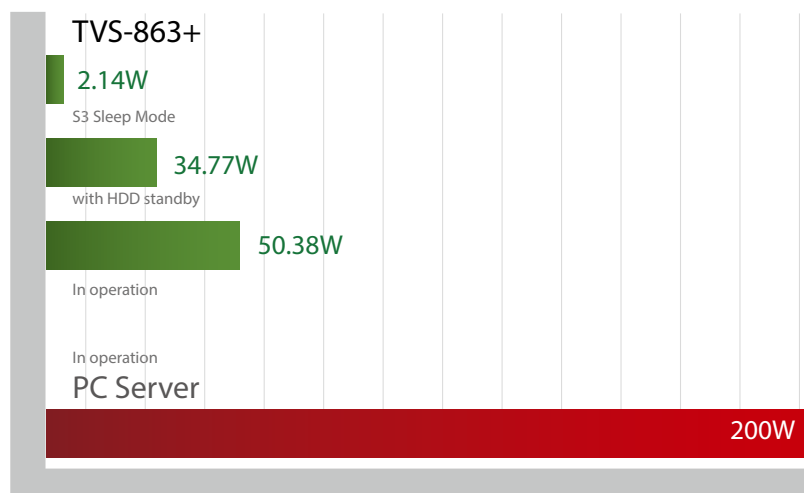

Seamless capacity expansion

The TVS-x63+ series offers a high performance yet affordable storage solution to fulfill the needs of business in archiving rapidly-growing data & large files. The TVS-x63+ series supports capacity expansion by connecting multiple QNAP expansion enclosures. With the QNAP scale-up solution, the raw storage capacity can be expanded on demand, making the TVS-x63+ series an ideal file center for storage-intensive business applications such as video surveillance, data archiving, TV broadcast storage, and more.

The QTS Storage Manager neatly presents tools and options for managing system storage. You can easily monitor the health status of expansion units and the disks within them. When multiple expansion enclosures are connected, the Locate Disk and Locate Enclosure functions assist you in quick maintenance.



The maximum raw storage capacity available by connecting RAID expansion enclosures:



Turbo vNAS Model	RAID Expansion Enclosure	No. of RAID Expansion Enclosure	Total HDD No. (NAS + Enclosure)	Max. Raw Capacity (TB)*
TVS-463	UX-800P	2	20	160
		1	12	96
	UX-500P	2	14	112
		1	9	72
TVS-663	UX-800P	2	22	176
		1	14	112
	UX-500P	2	16	128
		1	11	88
TVS-863+ TVS-863	UX-800P	2	24	192
		1	16	128
	UX-500P	2	18	144
		1	13	104

* The maximum capacity is calculated by using 8TB HDDs.

You can resolve the aforementioned scenario using the below steps.

- 1 Download Virtualization Station from the App Center and create a Windows®-based VM
- 2 Install the printer drivers in the VM
- 3 Map the destination folder into the Windows®-based VM, and set the folder as a network drive
- 4 Access the VM remotely via web browser to select a photo and then print it instantly



* The network usage of Virtualization Station is isolated from the Turbo vNAS. One Ethernet cable is reserved for the Turbo vNAS to use, so you will need to connect at least another one for the Virtualization Station to use.



How to map the destination folder into a Windows® VM? Please follow these steps : (Using Windows® 7 as an example)

- A Go to "Computer" and click [Map network drive]
- B Insert the IP address of your Turbo vNAS and click [Browser]. Select the folder you want to use and click [Finish].
- C This folder you want to use will appear as a network drive on your "Computer"

■ USB devices supported (USB Passthrough)

QNAP Virtualization Station supports connecting USB devices to virtual machines. Commonly-used USB devices can be connected to virtual machines, and you can select what device to use with Virtualization Station.

This can be used together with QVM Desk just as easily as using a PC. For document management, you can connect USB card readers/scanners to NAS via Virtualization Station, and store scanned data directly to the NAS without taking up Internet bandwidth.



Virtualization Station

▪ QNAP-exclusive virtualization technology

Direct access to files & data via VM

Specific file formats cannot be opened directly by the Turbo vNAS, but the Virtualization Station makes it possible. Administrators can install Windows®, Linux, and UNIX on the Turbo vNAS to run any supported application or file.

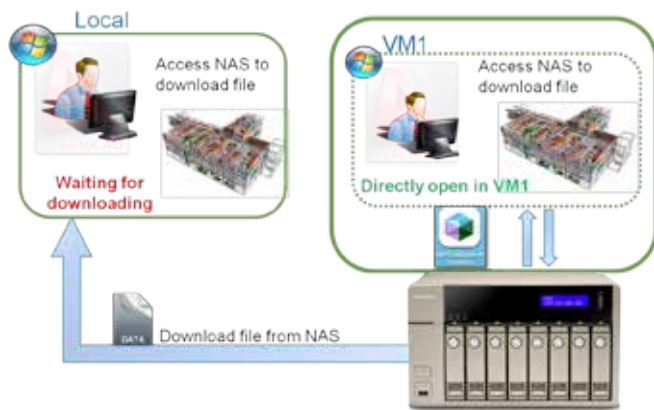

Save bandwidth & time

Downloading a large amount of data to a local PC has the potential to take a long time and use up network bandwidth. When accessing data on the Turbo vNAS through virtual machines on the Virtualization Station, you can enjoy secure data transmission and save bandwidth & time as the data is not transmitted via physical network cables.

Enhance security and save bandwidth

When accessing files & data on a virtual machine they are not transmitted outside of the Turbo vNAS. This provides a secure environment that prevents sensitive data from being intercepted and also saves bandwidth & network resources when you need to access large files.

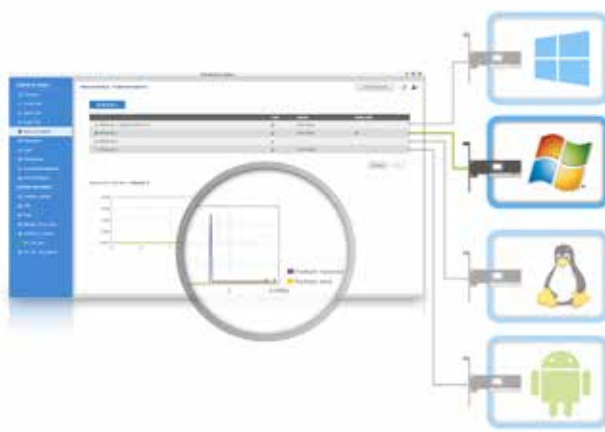

Dedicated network for VM only

The Virtualization Station provides functions for network monitoring. You can monitor all NIC (network interface controller) traffic and assign a specific NIC exclusively to a single VM.

User-based permissions settings

The Virtualization Station administrator can create users and set proper permissions for VM, helping to efficiently manage and allocate VM resources for users with different needs. With these permissions, users can work independently on their VM without worrying about their work being interrupted or data being lost because other users accidentally power off the VM.

User-based permissions include :

Console permissions : Control and View-only

VM controls : Snapshot and Advanced

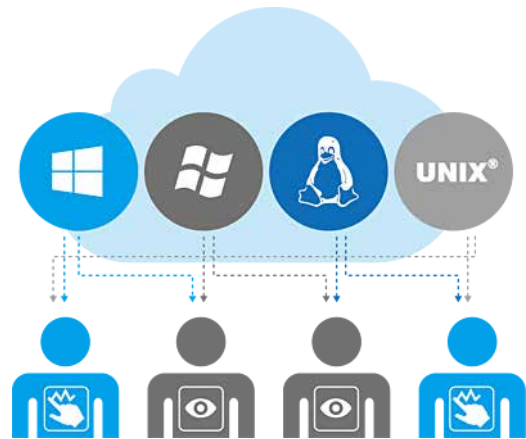

Operate VMs as Remote Desktops

Enjoy utmost convenience by operating Windows®, Linux and UNIX-based VMs as remote desktops. A list of buttons is provided on the left side of each individual VM display, allowing users to suspend, shutdown, force shutdown, reset, bring up key combinations + + & function keys, and even take snapshots for the VMs.



QNAP QVM Desk

QNAP QVM Desk supports local display for deploying virtual applications on a big screen when connected to a HDMI monitor, keyboard, and mouse. Compared to webpage operations it's smoother, more secure, and easier. Even when Internet connectivity is limited, you can still access data and run virtual machines on a NAS.

Budget-friendly QNAP Turbo vNAS for cloud computing

To meet the growing demand of cloud computing, solution providers offer a variety of services to their customers. Customers can leverage computing or application services with cloud computing in lieu of system maintenance and configuration. However, public cloud services can have shortcomings. Complying with high standards of security and evolving regulations as well as controlling long-term operating costs are among the major concerns of public cloud services. Most cloud computing pricing depends on the amount of resources consumed such as computing power and a subscription period. The integrated Virtualization Station of QNAP Turbo vNAS can help your enterprise develop a cost-effective strategy with the aforementioned unified storage to manage and store your data, potentially maximizing storage capabilities per TB. It is the industry's best private cloud architecture to counterbalance the disadvantages of public cloud services.

	AWS EC2	Rackspace Public Cloud	QNAP TVS-x63+ Series Virtualization Station	VMware vCHS	Google IaaS
Capacity	vCPU Cores : 2 Memory : 7.5 GiB Storage : 32GB SSD (m3.large)	vCPU Cores : 4 Memory : 4GB Storage : 80GB SSD (General 1-4)	vCPU Cores : Max. 4 Memory : Max. 16GB Storage : expandable, up to 24TB SSD	vCPU Cores : 2 Memory : 8GB Storage : 80 GB SSD	vCPU Cores : 2 Memory : 7.5GB Storage : 375 GB SSD
Available Regions	Global	Global	Global	U.S.	Global
Operating Systems ¹	Windows® Server	Windows® Server	Windows®, Linux, Unix and Android	Windows® Server	Windows® Server
Price ²	\$0.266 / hr	\$0.188 / hr	One-time investment ³	Calculated annually	Calculated annually

¹Cloud CPU capacity measurement varies from vendor to vendor; here we only present it with vCPU core numbers.

²The prices shown here are directly replicated from service providers' websites.

³The price does not include OS license fees for Virtualization Station.

The highlights of QNAP's exclusive QvPC Technology

■ Intuitive HD Station 3.0 (HybridDesk Station 3.0)

HD Station 3.0 is a monitor-based user interface based on QNAP's exclusive QvPC Technology. Simply plug in a keyboard, mouse, and HDMI monitor to the Turbo vNAS, and you can start the installation process and access data without connecting to a PC, tablet, or smartphone. A variety of local display applications are available on HD Station 3.0 including QTS, Mozilla Firefox, Google Chrome, QVM, XBMC and Surveillance Station. To enhance data security, user login controls are integrated to ensure only authorized users can access data stored on the Turbo vNAS through a HDMI monitor. HD Station 3.0 supports multitasking, international keyboards and input method editors and can be used like a PC to open different applications at the same time. The TVS-x63+ series supports mirrored display on 2 HDMI monitors, allowing you to watch exactly the same content on two different monitors.



* Note: 4K video playback and transcoding are not supported.

■ Streamlined installation : No complicated procedures necessary to install your NAS.

After purchasing a NAS, users usually install firmware from an installation disc and search for the NAS on their network, or log into the NAS manufacturer's website to complete the installation process. For users without relevant networking knowledge, this installation process may be difficult. Some users decide to purchase other external storage devices that can be instantly access (such as USB hard drives). However, these devices are "islands of information" that can only be accessed by the computer they are connected to. These storage solutions also have no protection against failure, and can be easily lost.

QNAP Turbo vNAS is an ideal solution for storing data. With QvPC Technology users only need to plug in a HDMI monitor, keyboard, mouse and follow on-screen instructions to complete their NAS installation. Even users without any network knowledge can easily set up and install a NAS. All files stored on a NAS are protected with RAID technology and are accessible via the Internet anytime.

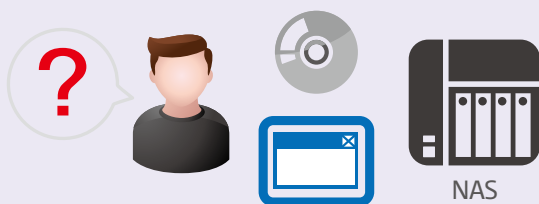

Conventional installation : You need an disc or to login to a website to complete the installation, and it can be complicated for general users.



Streamlined installation: Simply plug in a monitor, keyboard and mouse and you can quickly complete the on-screen instructions to complete the installation.

QvPC Technology

- QNAP QVM Desk turns a NAS into an office PC



Run Windows®, Linux and Android virtual machines on a HDTV

Leveraging virtualization technology, QNAP QVM Desk supports local display for a virtual interface and turns the NAS into a PC when connected to a HDMI monitor, keyboard, and mouse. Any files on the TVS-x63+ can be opened using virtual machines running Windows®, Android, Linux, and Unix through QVM Desk. You can also instantly switch between different virtual machines to meet your needs, just like using multiple PCs at the same time. Compared to the operations via a webpage, it's smoother, more secure, and worry-free to do on a NAS. Even when the Internet connectivity is limited, you can still access data and run virtual machines on a NAS.



Run Android on a NAS with QvPC

Have you ever feel constrained by the lack of storage space on your tablet or smartphone and have no idea where to back up your files or what apps to delete for more space? With QvPC Technology, you can run Android on a virtual machine, and back up apps or files like LINE, WeChat, Gmail, your phonebook, photos, and chat messages from your Android device to the virtual machine with backup software like App Backup & Restore and My Backup Pro. This way, the files on the public cloud can be stored on your private cloud. You no longer need to worry about having difficulty accessing your data anymore. In addition, your NAS can be transformed to an Android device and the millions of apps on Google Play can be operated on it as well.



LINE



WeChat



Gmail



Facebook



To learn more about QNAP Virtualization Station, visit <http://www.qnap.com/i/station/en/virtualization.php>



Defense Desk

24/7 safeguards your office and property

Live-view

QvPC Technology supports local display of live surveillance feeds on the screen with a QNAP remote control. You don't need an additional PC for live-view, nor do you need an Internet connection to check the stored video recordings. You can monitor up to 16 channels simultaneously, adjust PTZ functions, and conduct audio surveillance. QvPC also supports instant notification functions and will show alerts on the monitored page should any incident happens, helping you take immediate action and control the work environment more efficiently.



Playback

You can connect your Turbo vNAS to a monitor to playback recordings. Just select a timeframe, and you can search the recordings within this period. It also supports video fast-forwarding and rewinding (up to 16x speed). You can quickly look for detailed images with the zoom function, and listen to audio for key background sounds during the playback.



To learn more about QNAP Surveillance Station, please turn to Page 51.

Manage Local Display Desk easily



Quickly install QTS and access files

Just plug in a HDMI monitor/TV, keyboard and mouse to a TVS-x63+, and within a few simple steps you will complete installation and be able to access files using the QTS operating system.





Surf the web via Chrome/Firefox on TV

QvPC Technology supports HDMI-out and Google Chrome/Firefox, allowing you to surf the web easily, and is ideal for offices to build a information search center with minimal costs.



Build an online music center with Spotify

Over a million songs can be found on Spotify. Create a media center and enjoy your music collections with your NAS while at work.



Qremote mobile app turns your mobile device into a handy remote control

iOS and Android users can download the Qremote app to turn their smartphones into a remote control to conveniently play videos, music, and photos on TV via HD Station 3.0. The Official XMBC Remote app can also be used.



Unified Storage Management

QNAP Turbo vNAS series is unified storage which can serve as iSCSI SAN storage and NAS. The powerful Storage Manager assist you to manage iSCSI LUN and volume efficiently.

Intelligent Storage Manager

The QTS 4.1.2 Storage Manager neatly presents tools and options for managing system storage with an intuitive graphical interface. From reviewing the system storage allocation in the Dashboard, to managing volumes, Storage Pools, disks and iSCSI storage, the Storage Manager provides a centralized place to ease the work of storage management.

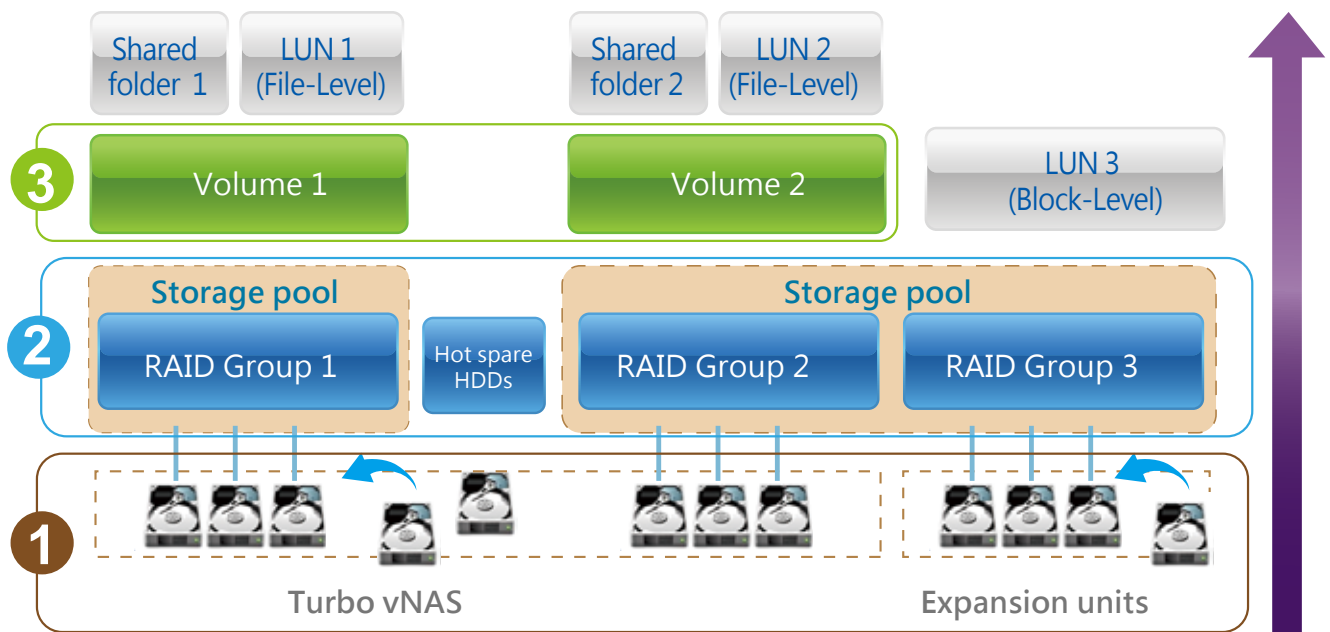

Dashboard

The Storage Manager dashboard presents an overview for IT administrators to check storage allocation status easily.



In addition to Storage Manager, IT administrators can also check the storage pool and volume status on File Station.

Shared Folder	Used Size	Volume	Capacity	Free Size	Volume Status
QData/Backup	2.13 GB	Backup	2315 GB	2313 GB	Ready
Home	64.20 KB	DataV01	497 GB	496 GB	Ready
Public	1.31 GB	DataV01	497 GB	495 GB	Ready
QNAP	0.50 KB	DataV02	652 GB	652 GB	Ready

1 Disk information

Click to check disk information and disk health, scan the disk, locate the disk, or check the disks within the RAID Group.



2 Storage Pool

IT administrators can aggregate multiple RAID groups as a big storage pool to flexibly utilize the storage capacity as a whole, protect them using redundancy and allowing for better protection against multiple disk failures for large-capacity environments. Multiple volumes can now be created on the Storage Pool to provide flexible deployment.

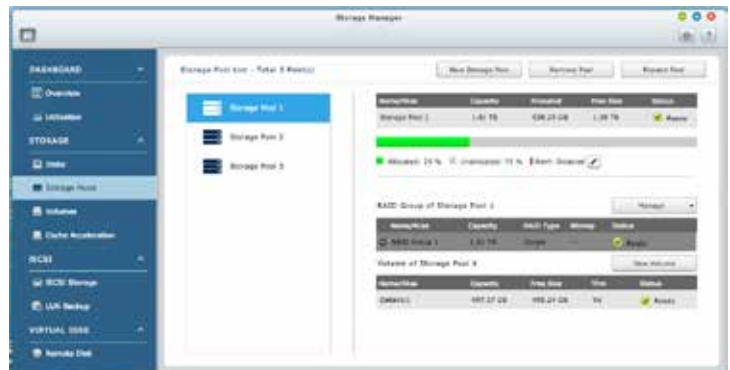

3 Flexible Volume Allocation

QTS 4.1.2 allows creating multiple volumes on the Storage Pool for various applications in typical business environments with different workgroups. Each data volume and LUN can be extended up to 250TB without interrupting services.

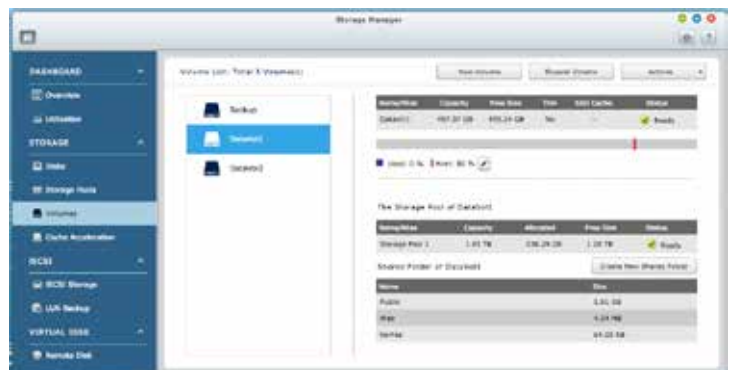

Thin provisioning

Over-allocation allows a server to view more storage capacity than has been allocated in the storage pool. Furthermore, physical storage capacity is used only when files are written by the application, thereby improving utilization rates.

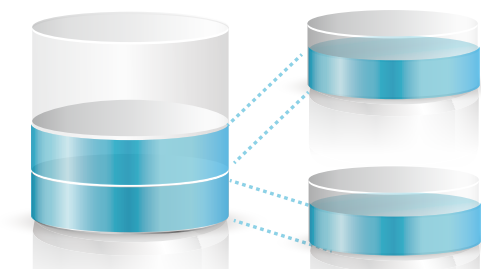

Efficiently use storage spaces with incremental allocation.

Thick provisioning

Physical storage capacity is dedicated upfront when the storage volume is initially allocated.

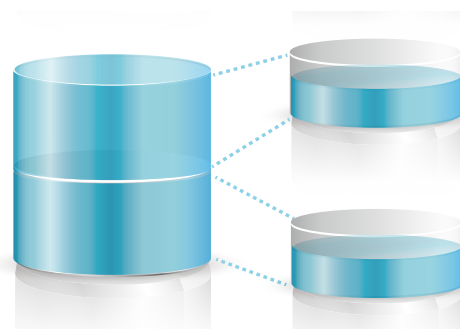

Allocate all spaces specified and they cannot be used by other volumes or LUNs.

▪ iSCSI LUN

QTS 4.1.2 supports two types of LUN for efficient storage utilization: block-level and file-level iSCSI LUN. The TVS-x63+ series also supports multiple types of configurations for server connections□

- single LUN or multiple LUNs per iSCSI target.
- multiple iSCSI targets for a single LUN, only used for clustered environments

Block-Level iSCSI LUN

Besides storing data, volumes can be utilized as an iSCSI LUN. The block-level iSCSI LUN provides less overhead which improves the overall read/write performance.

File-Level iSCSI LUN

Users can consider file-level iSCSI LUN if there isn't enough space for block-level iSCSI LUN. The file-level iSCSI LUN can be used for creating a disk image for an iSCSI LUN.

Both block-level and file-level iSCSI LUN support thin provisioning, space reclaim, and online capacity expansion. We recommend using block-level iSCSI LUN unless there is a limitation on space usage.

▪ Virtual Disk Drive - Increase flexibility of storage expansion

Virtual Disks provide a more flexible way for IT administrators to expand storage. By using the built-in iSCSI initiator to connect an iSCSI target of the TVS-x63+, you can create a virtual disk on the local server. The TVS-x63+ can be a stack master to connect up to 8 virtual disks or stack targets, aggregating storage space from multiple NAS systems. Thus, all NAS users only need to connect to a single target to access the space from all of the network storage devices.



For every virtual disk on the local server, it will be seen as a single drive of disk arrays.

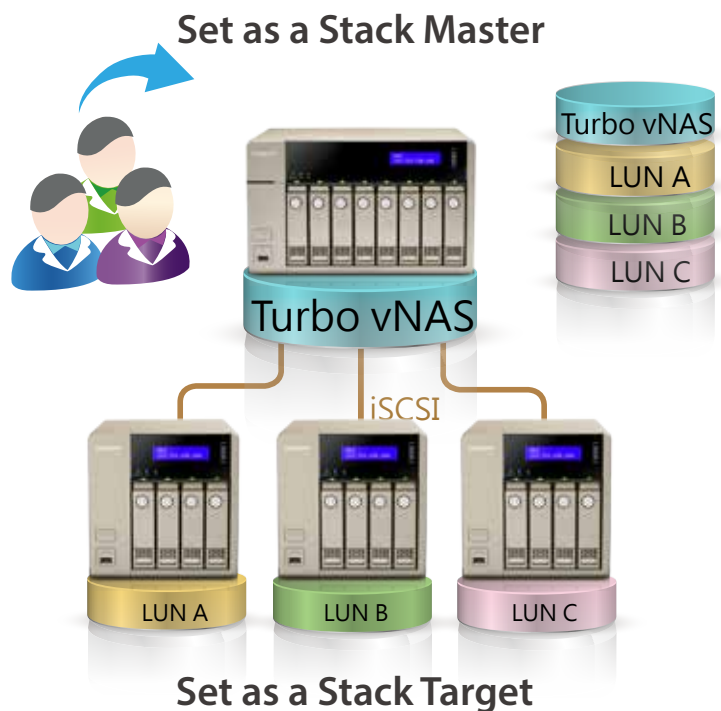

■ QNAP high-performance unified and tiered storage solution

Data used by enterprises continues to grow exponentially and with greater diversity in data types and importance. It is imperative to offer a secure and efficient storage solution that can process this enormous amount of data while minimizing the total cost of ownership.

Establishing a tiered storage system based on efficiency and capacity can aid in improving overall processing efficiency. Enterprises can classify data accordingly by sharing folders with a file-based storage system and processing files that require more demanding data throughput with a block-based storage system to accommodate different usage models.

The TVS-x63+ Series can flexibly configure different tiers to hard drives on a single unit according to different data usage needs, delivering the best unified and tiered storage solution.

■ Tiered storage for better efficiency

In the cloud era, enterprises need a storage architecture that can provide rapid access to dynamically scalable and virtualized IT resources. Classifying data into Hot Data (frequently-accessed) and Cold Data (rarely-accessed) to store them in a tiered storage can help achieve this goal efficiently and cost effectively. Businesses often use SSD to improve the overall workflow of random IOPS demanding applications such as databases and virtualization. Different types of storage media are used for different purposes. Hence, it is better to utilize different storage media according to the system requirements.

	Tier 1	Tier 2
Storage Type	SSD	SATA HDD
Characteristics	Balance of efficiency, capacity and usability	Ubiquitous, convenient, and inexpensive
Usage Scenario	Online transaction processing (OLTP) Systems and ERP databases	Archiving, online and offline backup storage, disaster recovery
Usage Examples	Data, audio, email, database table, and video creation and other operations of the workflow in a virtualized environment	Low cost and energy saving
Typical Use	A wide variety of users and environments where performance is crucial	Typical for Data at rest
Criteria	Weighs more on IOPS, throughput and resiliency	Weighs more on data volume and low cost per TB

The following is a comprehensive comparison of general tiered storage devices.

Hard Drive	Solid State Drive (SSD)	SATA Hard Drive
Features	Low power consumption, no noise, antivibration, low heat, fast speed	Large capacity, lower reliability and performance
Price	\$\$\$\$\$\$	\$
Capacity	100GB~800GB	500GB~6TB
Performance	Very high	Moderate-low
Interface	SATA (Single Port) 6 Gb/s	SATA (Single Port) 6 Gb/秒
RPM	N/A	7200-RPM
External Continuous Transfer Performance	800	170
Average Response Time (Milliseconds)	N/A	R : 9.5/W : 8.5
Input/Output Operations Per Second (IOPS)	120,000/40,000	Less than 100
Unrecoverable bit read error	1 LBA per 10E16	1 LBA per 10E14
Mean Time Between Failures (MTBF, hours)	NN/A	0.8 million

File Management (File Station)



File Station

With File Station, you can easily manage, upload, download, share files, and enjoy media playback anywhere with a web browser. File Station brings conventional file operations performed on the computer desktop to the web browser.

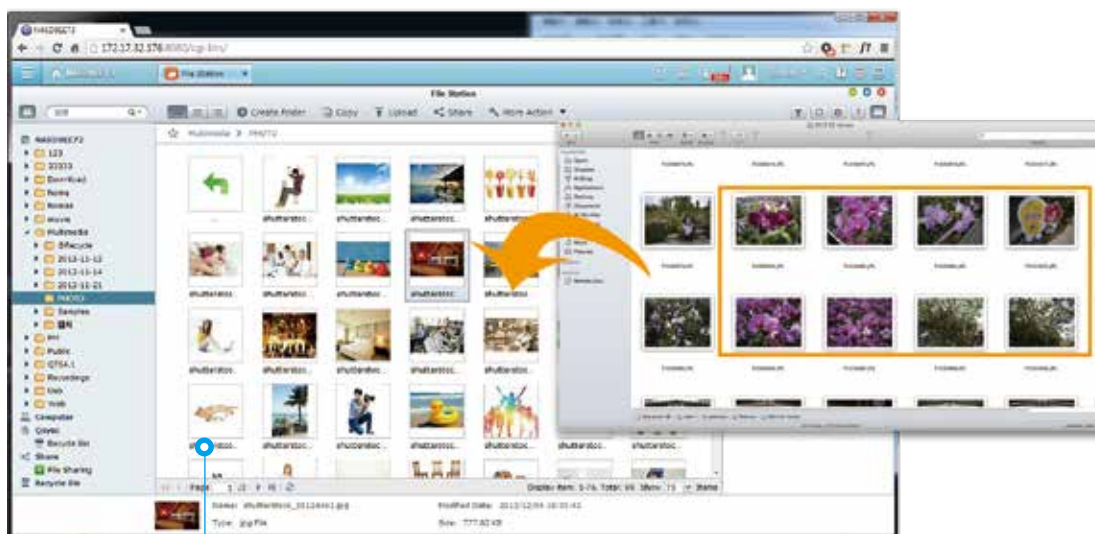

File upload

Easily upload the files to your Turbo vNAS by dragging and dropping them into File Station.

Photo slideshow

Right-click on selected photos to play a smooth slideshow.

Mutual file sharing

You can easily share multiple files in a shared folder with friends via a Share Link. By activating the file upload function, your friends will be granted the privilege to upload files to your File Station without requiring a user account. You can even set an expiration time for shared files.



Media streaming & playing

File Station supports VLC for multimedia streaming. Just click on your photos, music and videos to directly play them. The slideshow display helps gather media files in an organized manner for you to preview and play.



Click and play videos

TVS-x63+ supports realtime transcoding which allows immediate and smooth video, music, and photo playback. No need to wait for the files to be converted in advance.



Real-time transcoding allows maximum 12 users to simultaneously connect and watch videos. Offline transcoding allows more users. Check page 43 to learn more about transcoding feature.



Recycle bin

The recycle bin helps retrieve files accidentally deleted. It is categorized by shared folders to increase file retrieval efficiency.



Advanced quick search

File Station provides smart filters for file searching and browsing by file size, modified date, file name, and so on. Pop-up thumbnails enable you to quickly & clearly preview files. File browsing is more intuitive with File Station.

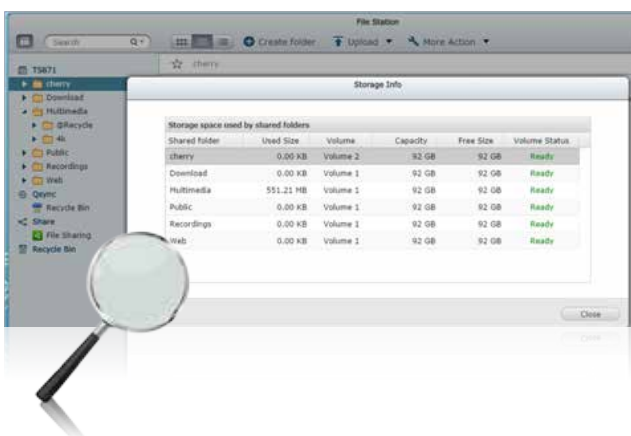

Photo thumbnails preview

File Station makes file management easier by showing thumbnails of photos, music and videos.

Check shared folder usage and space utilization

The updated user interface of QTS 4.1.2 File Station provides a detailed view of the designated volume and space usage of the shared folders to assist you manage space utilization.



Compress/Extract multiple files

If you need extra space you can easily compress files & folders into a Zip file. You can also easily unzip files straight to File Station.



File Management



Qfile: Share files with mobile devices

You can install the Qfile app on your mobile device to browse and manage files stored on your TVS-x63+ anytime, anywhere.

Access from anywhere

Open Qfile on your mobile device to browse files on the TVS-x63+. You can open or share files, and easily rename, copy, move, download any selected files.

Auto-upload photos

Automatically upload photos to your TVS-x63+ whenever you take new photos. It works as a real-time backup of your precious photos.

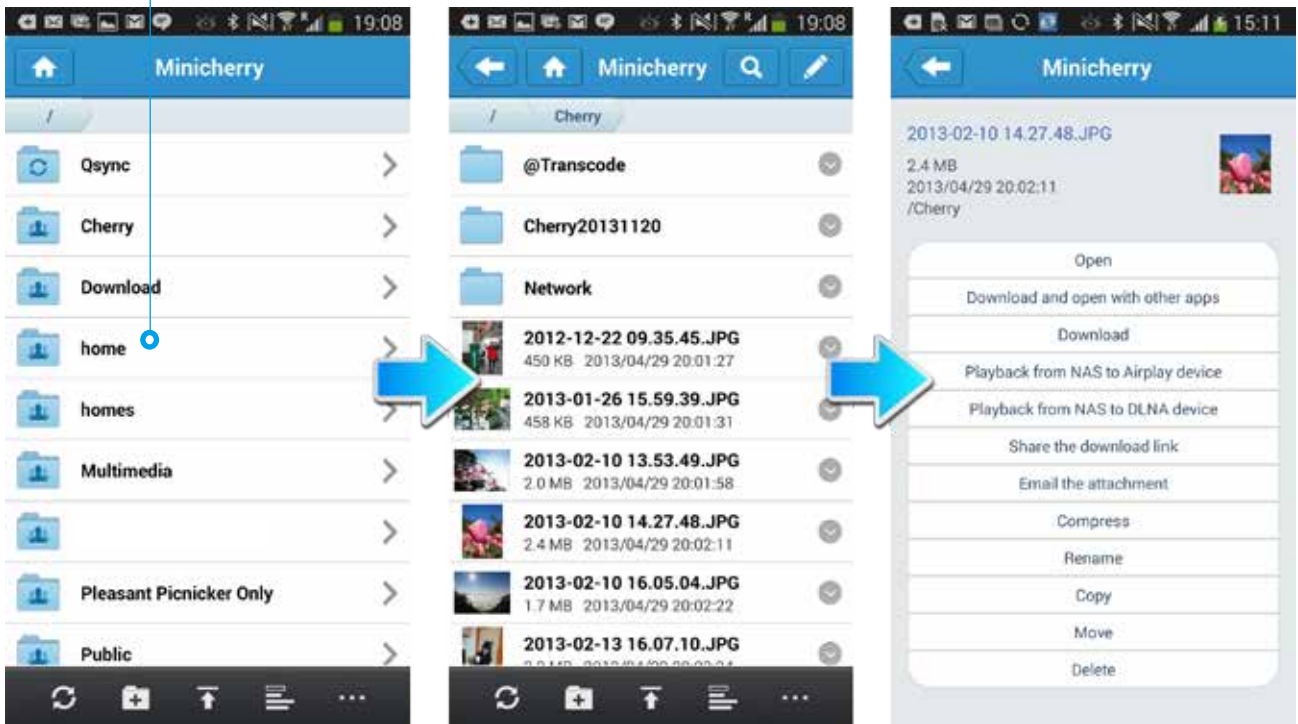

Qfile will download the file to your handheld device and send it via your default email function. This file cannot exceed 20MB, so please ensure there is enough free space on your device to save the file.



Install Qfile on your mobile device to browse and manage files stored on your Turbo vNAS anytime, anywhere.

Available on the
App Store



Google play





Stream multimedia contents

Use Qfile to stream multimedia content to AirPlay or DLNA-compatible devices and play to enjoy.

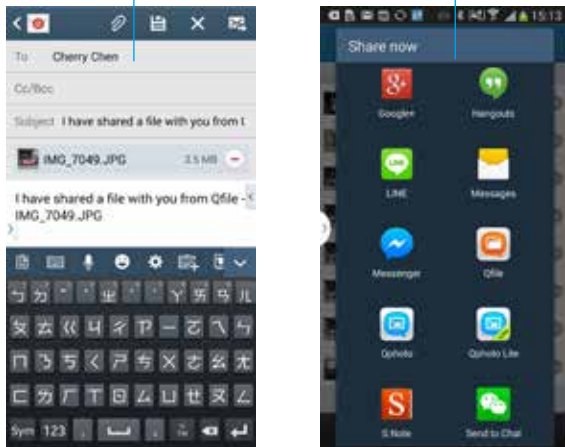

Share files instantly

Qfile provides various ways for instant file sharing, including email or SMS. Qfile also provides Share Links to easily share large files. You can paste the Share Link on instant messenger such as LINE, WhatsApp, WeChat, and more to share files with others.

Your friends can click on the Share Link to download the files.





Q'center CMS (Central Management System)

Previously, IT administrators need to log in to Turbo NAS units individually to check their status. The QNAP Q'center CMS (Central Management System) offers a platform to centrally manage multiple NAS units. You only need to install Q'center on the master NAS and set all other Turbo NAS units as managed stations. You can also monitor and update firmware for all Turbo NAS units at once with this centralized management utility.

Q'center Network Architecture

In order to use Q'center to monitor multiple Turbo NAS units, you have to set up the master Turbo vNAS and other managed devices in the same network environment. QTS 4.1.2 provides the VPN server and VPN client function, making it easy for IT managers to establish the internal network architecture for Q' center deployment. Just set the master device as a VPN server and other devices the VPN clients, and the internal network environment will be established by VPN protocol automatically.



The Best Utility for IT Administrators

▪ Increase IT management efficiency

1. User-friendly management interface

Not only can you monitor the system status for all Turbo NAS units, but you can also view their firmware information and system logs. You no longer need to log in to NAS units individually for such information. Besides viewing system information, IT administrators can update the firmware for all Turbo NAS units at once with a single click.

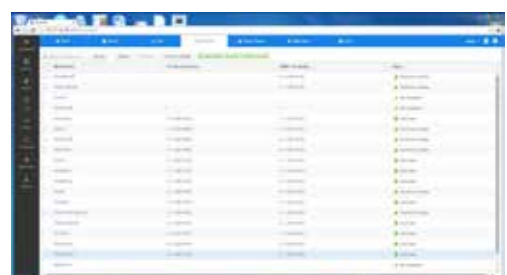

2. Simplifying IT Asset Management and System Configurations

Q'center presents aggregate reports of all Turbo NAS units based on the characteristics of a NAS system or its components such as models and disk capacity, helping you keep track of all your storage assets. It also allows IT administrators to configure the same system settings across multiple NAS units, significantly reducing configuration time and effort. Available configurations encompass general system settings from network to domain security and network services.

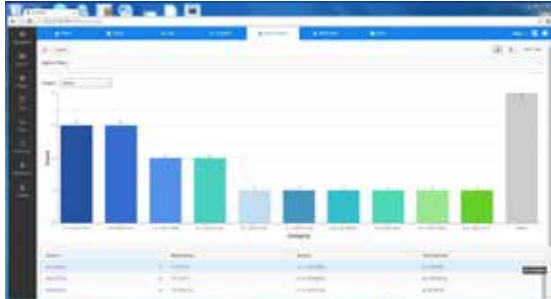

Name	Type	Description	Available Space
Unit 1	File	10TB File System	10000000000000
Unit 2	File	10TB File System	10000000000000
Unit 3	File	10TB File System	10000000000000

- **Enhance system availability**

Q'center has an email notification function to notify administrators of any predefined system conditions. You can set up alert policies based on the criteria such as CPU usage or volume usage for a group of selected NAS units, and you will be alerted if any one of the criteria of a policy is met.

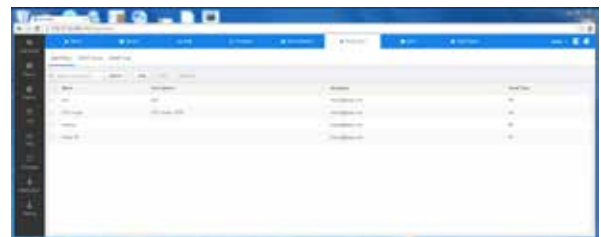

- **Increase storage utilization rate**

IT administrators can monitor capacity usage on every Turbo NAS to gain information about space utilization. They can better allocate storage resources based on the information to maximize the utilization rate on each Turbo NAS.

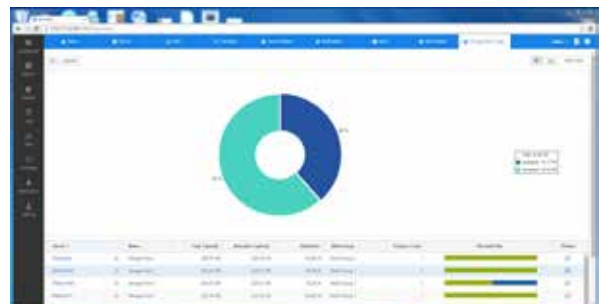

- **Enhance reliability and serviceability**

By monitoring CPU, memory usage and other performance indicators on a daily or long-term basis (e.g. monthly or yearly), you will gain a complete view of how well the system performs. You can also analyze how certain tasks (such as download, file conversion, or encryption) affect the overall system performance. Furthermore, IT administrators can check system performance anytime to help them redistribute tasks or loads among NAS units or upgrade their systems if they find differences in performance.

The report function can generate a series of charts and graphs that display system information to help IT administrators proactively plan system upgrades and respond to system failures or degradation, as well as evaluate how effective the storage is used. Statistics collected can be kept for an entire year for capacity planning.

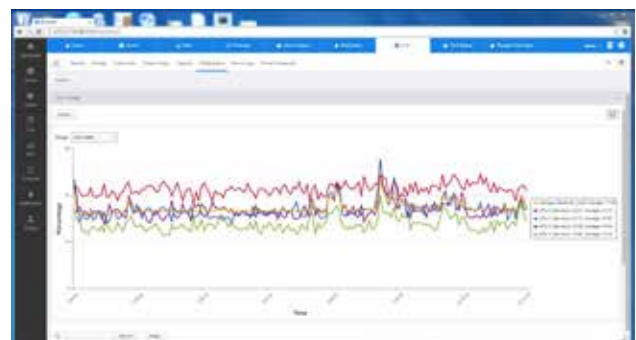

Intuitive & Simple QTS 4.1.2 OS

Based on Linux, QTS 4.1.2 is designed to be simple and flexible while centralizing multiple applications efficiently in the App Center.

Multi-Window : Simultaneous multi-window operation for easy usage.

Multi-Task : Improve work efficiency by performing multiple tasks at the same time.

Multi-Device : Synchronize cross multiple devices anytime, anywhere.

Multi-App : Use a range of easy-to-manage apps and download more as needed.

Multi-Scenario : Customize your own cloud platform with multiple applications.

■ Intelligent Desktop

QTS 4.1.2's intelligent desktop offers an intuitive, sleek, and easy-to-follow graphic user interface that simplifies your Turbo vNAS experience. It allows you to open multiple application Windows® and simultaneously run multiple tasks. Application Windows® can be minimized to the toolbar to allow you to see an overview of the opened applications and switch between running applications.



Smart toolbar



Background tasks

Displays all the active and scheduled tasks performed in the background.



External devices

Access connected storage devices and safely eject them with a single click.



Event notifications

Updates you with system information including warnings and other error messages.



Quick search

Quickly search for system settings and QTS Help.

Main menu

All of your applications, system preferences, and additional apps installed from the App Center are neatly presented for you to quickly find your desired app. Drag and drop frequently used icons to the desktop as shortcuts for easier access.

Multiple desktops

The extended desktop workspace is specifically designed to improve your productivity. You can move apps to different desktops according to their category and freely switch between them.

Smart dashboard

In just one click the smart dashboard presents all the important system information in a single panel. Drag any status to the desktop for constant monitoring.

Customized Login Page

Public photo wall and app shortcuts on the login page

Customize the photo wall based on your company image and display it on the login page. Each app has its own shortcut that you can place on the login page to allow direct access without the need to log into QTS first.

Enable this option and ...

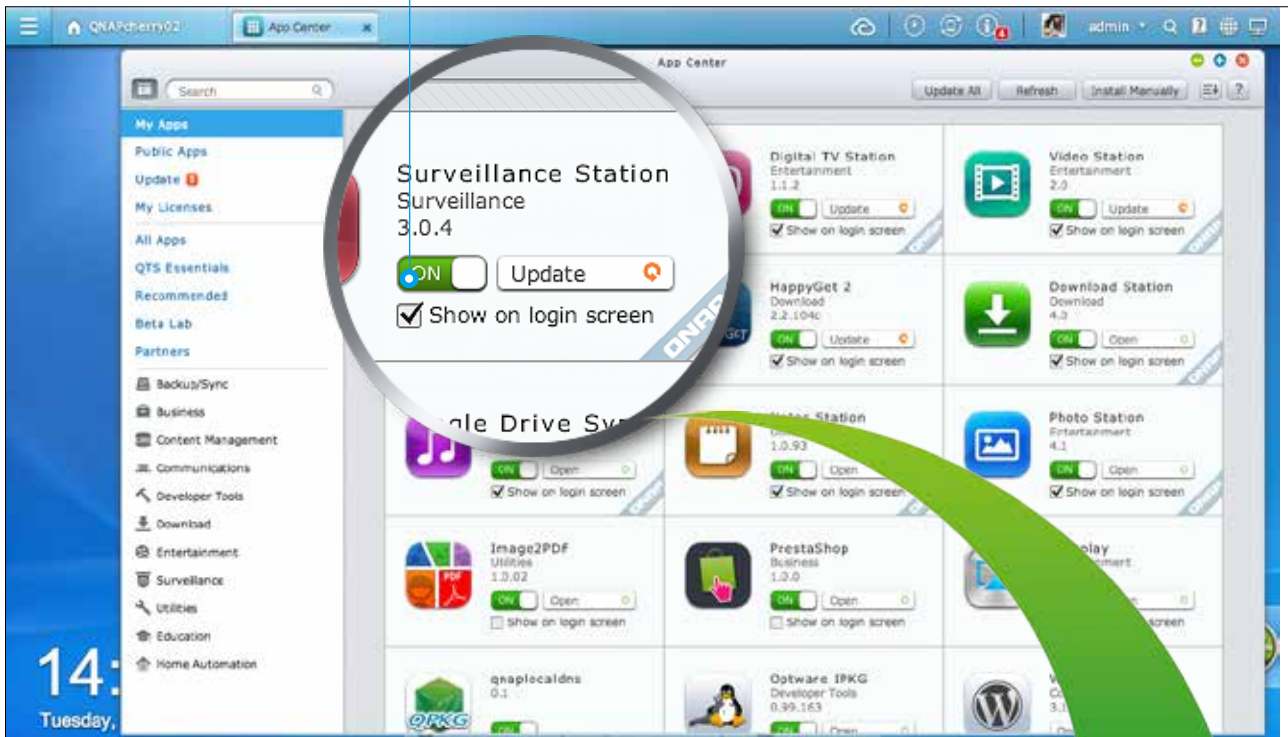

Display the app shortcut on the login page.

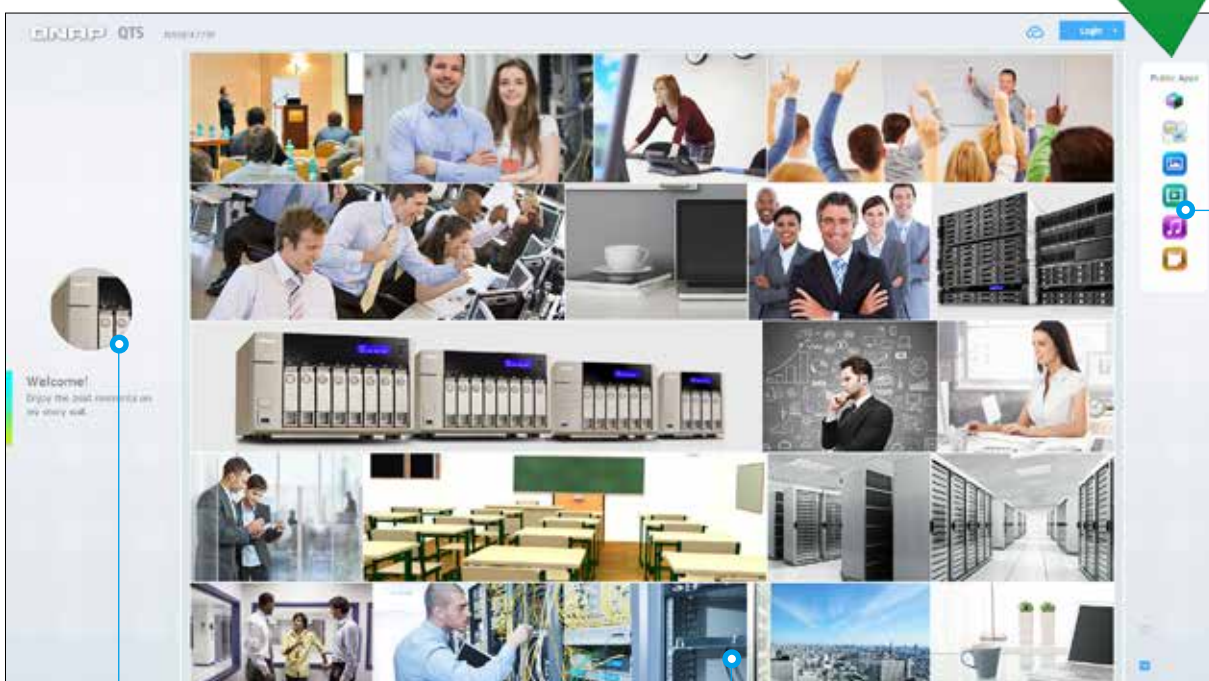

Customized admin photo

Public photo wall

NAS connection and network settings



Qfinder for connecting to a NAS

Instant connection and NAS setup

Qfinder is a utility for Windows®, Mac, and Linux that lets you quickly find and access the Turbo vNAS over LAN. Install Qfinder on your computer, open it, and double click your Turbo vNAS name and the login page is ready for you.

Model	IP Address	Model Name	Serial No.	Version	MAC Address
Ken879	10.8.12.122	TS-879 Pro	4.0.0 (20130307)	00-00-08-79-00-27	
Marketing	10.8.13.89	TS-869 Pro	3.8.2 (20130301)	00-08-9B-D2-56-C4	
NAS802751	10.8.12.101	TS-809U	3.8.2 (20130301)	00-08-9B-8D-27-51	
NAS84C606	10.8.12.152	TS-670 Pro	4.0.0 (20130328)	00-08-9B-D4-C6-06	
juux670	10.8.13.106	TS-670 Pro	4.0.0 (20130401)	00-08-9B-D4-C6-06	
HAI	10.8.13.240	TS-659 Pro+	4.0.0 (20130322)	00-08-9B-00-02-34	
CSD-659ProII	10.8.12.105	TS-659 Pro II	3.8.2 (20130301)	00-08-9B-C7-77-8F	
ANAS8092AB	10.8.13.58	TS-659	4.0.0 (20130325)	00-08-9B-8D-92-AA	
NAS8A870	10.8.12.84	TS-639	3.8.2 (20130301)	00-08-9B-8A-9B-70	
PM	10.8.13.139	TS-639	3.5.1 (10027)	00-08-9B-8A-95-82	
Art-CS0559	10.8.12.80	TS-559 Pro+	3.8.2 (20130301)	00-08-9B-C7-64-3F	
NASC3806	10.8.12.93	TS-559	3.8.2 (20130301)	00-08-9B-C3-C8-06	
PM8095	10.8.12.95	TS-559 Pro+	4.0.0 (20130401)	00-08-9B-8D-C7-C6	
NAS8B078	10.8.12.145	TS-509	3.8.1 (20121207)	00-08-9B-8C-A4-79	
Fan-509	10.8.12.132	TS-509	3.8.2 (20130120)	00-08-9B-8D-08-10	
juux509	10.8.13.54	TS-509	3.8.2 (20130301)	00-08-9B-89-28-18	
MicroNAS	10.8.13.134	TS-509	3.8.2 (20130301)	00-08-9B-89-28-18	



Easy access to NAS with Storage Plug & Connect

The Windows® version of Qfinder provides a convenient way to connect to the Turbo vNAS and map a network drive or virtual disk. By creating a shared folder on the Turbo vNAS and mapping it as a network drive, you can use it as if it were a local drive on your computer.

System network setup

TCP / IP and service connection setup

The TVS-x63+ series offers up to 4 LAN ports. You can click on the QTS [Control Panel] > [System Settings] > [Network] to activate service connection, assigning QTS applications to one or more network interfaces (over LAN or wireless). The Turbo vNAS will allow application access based on IP sources to optimize the LAN ports utilization for your network environment.



Optimize network resources with high security

You can assign each LAN port for different applications to optimize network resources and increase security (for example : Public IP, Intranet, Server Backend Network, VM Network, etc). When using Virtualization Station, the network traffic from the virtual machines (VMs) is isolated from the network used by the Turbo vNAS. The bandwidth for the Turbo vNAS applications will not be impacted by the VM operations, and the VMs can have dedicated bandwidth for operating high-traffic applications. Also, you can flexibly install a NIC and arrange other LAN ports for different VMs to use as a dedicated network resource.

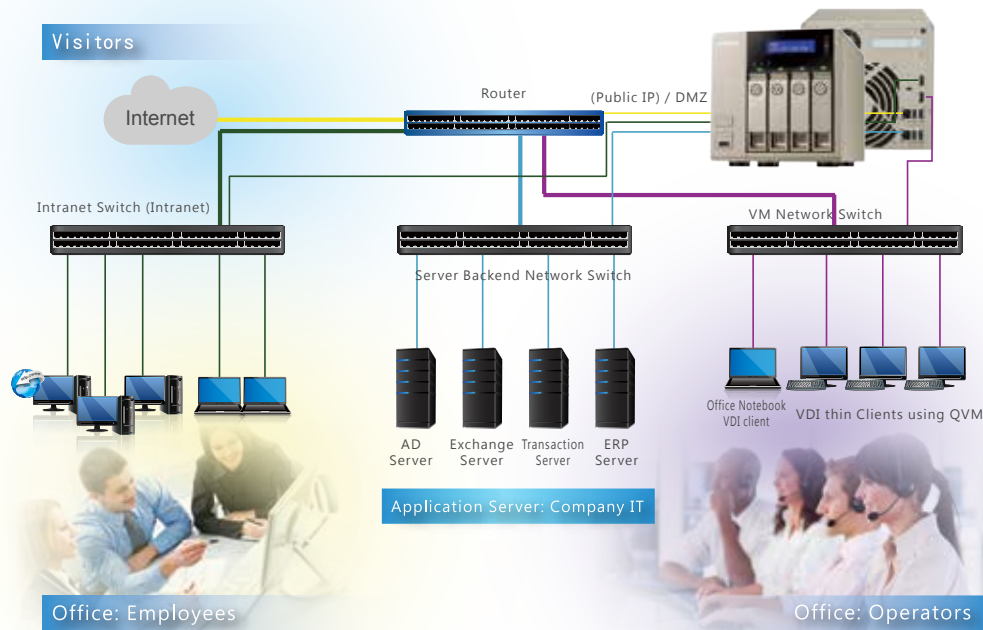

Port Trunking - Link Aggregation for high-speed and high-security file transmission

Including the practice mentioned above, 2 LAN ports can be used for Port Trunking - Link Aggregation, enabling IT administrators to set up link aggregation to increase total data transmission capabilities and achieve better efficiency for IT operations. Failover, load balancing, and multi-IP settings are also supported.

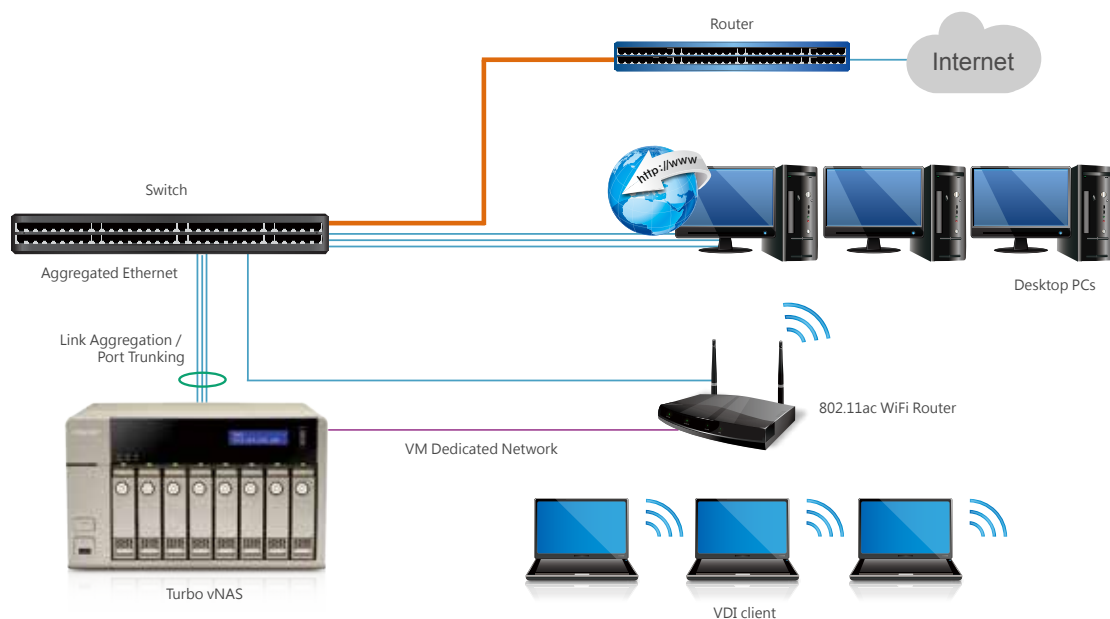

QTS 4.1.2 OS

Wi-Fi network settings

The TVS-x63+ supports Wi-Fi networks. Connect a USB Wi-Fi network card to the NAS, click QTS [Control Panel] > [System Settings] > [Network] > [Wi-Fi], and the available Wi-Fi access points will be listed. The QTS 4.1.2 supports 802.11ac Wi-Fi network protocols. You can connect the TVS-x63+ to a router supporting 802.11ac protocols for higher file transfer speeds.

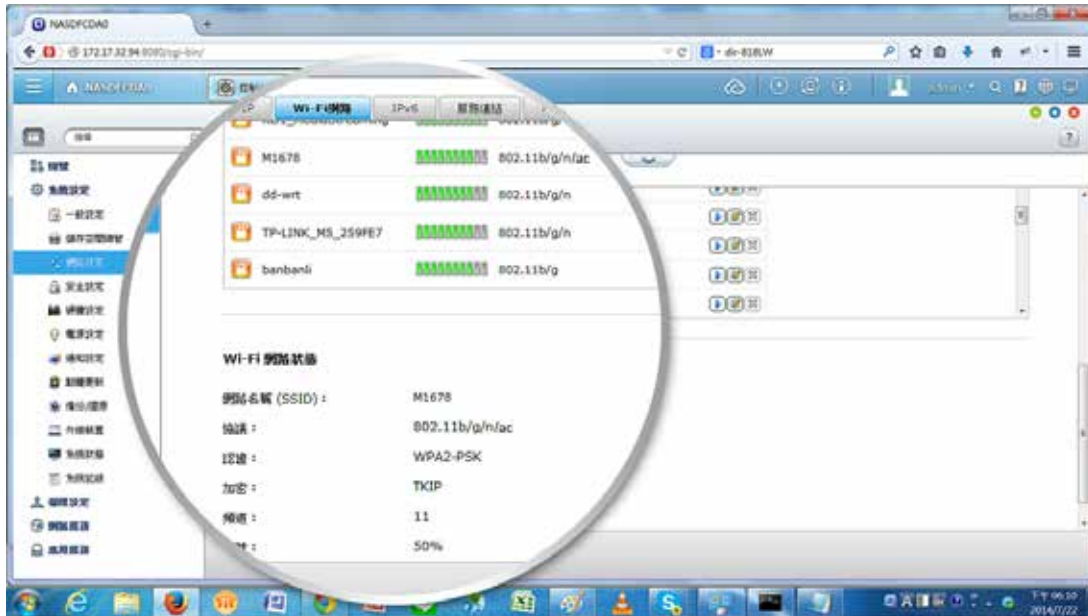

A Turbo vNAS can support a USB Wi-Fi network card. Visit www.qnap.com for a full Wi-Fi network card compatibility list.

Dynamic DNS (DDNS) service

After connecting to the Internet, click [Control Panel] > [System Settings] > [Network] > [DDNS Service] to get the Internet IP address. The IP address can be a DHCP or a fixed address according to your Internet Service Provider (ISP). You can use the IP address and register a DDNS on a DDNS server. By properly setting up DDNS, the Turbo vNAS ensures that it is always reachable by automatically updating its IP address with the DDNS service provider whenever the IP address changes.

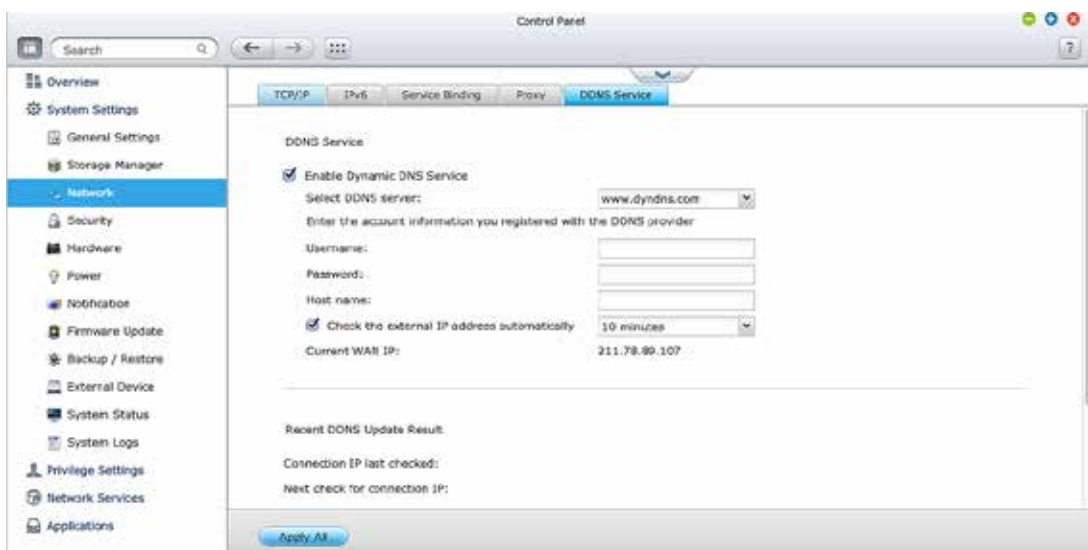

Application Server

QTS 4.1.2 integrates numerous server functions, including web server and printer server.

■ Web Server

QTS has a built-in Web Server with PHP/MySQL support and allows hosting multiple websites and running web applications on the Turbo vNAS such as Joomla, phpBB, and other online marketing platforms.



■ FTP Server

Large file sharing

Use FTP for high-speed data transfer and increase the efficiency of large file sharing.

Flexible settings

Use anonymous login, read/write, read-only control or bandwidth control to flexibly manage the access right control.

Secure access

Use the safe FTPS (FTP over SSL/TLS) connection to ensure secure data transmission.

■ Printer Server

QTS supports printer server, with the support for IPP (Internet Printing Protocol), Samba, print job management, and Bonjour printing on Mac OS X. By connecting a compatible USB printer to the Turbo vNAS, members can instantly share the printer resources over the network at the same time (Max. 3 USB printers).



Security Management

QTS 4.1.2 offers various security management options to protect the system from hacking and data from interception, theft and loss. QTS security management meets the electronic requirements of HIPAA (Health Insurance Portability and Accountability Act), performing as an ideal storage solution to store medical records.

Privilege settings

Windows® AD/ACL

QTS 4.1.2 supports Windows® AD/ACL to help IT administrators manage user accounts more effectively, and to simplify the process of privilege settings in large-scale organizations. QTS 4.1.2 also supports SAMBA v4 that enables the Turbo vNAS to serve as a Windows® domain controller to manage privilege settings.

LDAP Directory Service

QTS 4.1.2 supports the LDAP protocol, integrating the Turbo vNAS into networks that have deployed an LDAP-based directory service such as OpenLDAP and greatly simplifying the efforts of managing a large amount of user accounts. QTS 4.1.2 makes Turbo vNAS a LDAP server too.

Anti-hacking

IP blocking

IT administrators can set up the black and white lists to grant proper access from different users to the Turbo vNAS by IP address. It operates as a policy-based automatic IP blocking by enabling the network access protection command.



Anti-virus

QTS 4.1.2 integrates the ClamAV antivirus toolkit to defend against the latest viruses, malware, worms, and Trojan horses with continuous free virus database updates, ensuring continuous business operation. An email notification upon task completion or virus detection is provided. QTS 4.1.2 also supports McAfee virus scanner which is available in the QTS App Center with a free 30-day trial.

Radius Server

QTS RADIUS Server provides centralized authentication and authorization management for computers to connect and use a network service. The QTS RADIUS Server maintains a list of user accounts that are authorized for remote network access through dial-up equipment, Wi-Fi access point, or VPN connections. IT administrators can easily apply access policies to multiple access points for a fine-grained control of network access.



Anti-theft

Hard drive encryption

QTS 4.1.2 supports up to AES 256-bit encryption for internal drives and external USB/eSATA drives, and adopts a military-level FIPS 140-2 validated encryption, which is considered to be the highest security certification for compliance.

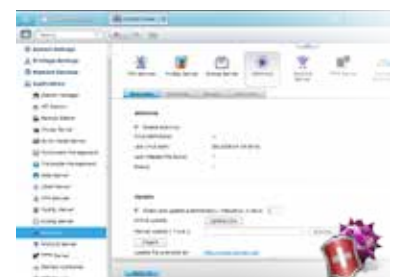
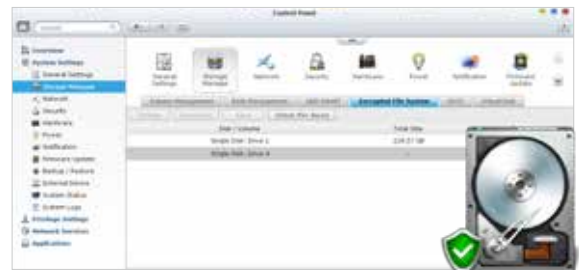

Anti-interception

VPN Server

QTS 4.1.2 supports VPN Server, with VPN connections secured with up to 256-bit encryption. It is easy to configure and is seamlessly integrated with the QNAP myQNAPcloud service and Auto Router Configuration. Complicated port forwarding settings for PPTP and OpenVPN are therefore simplified.

Encrypted access

QTS 4.1.2 supports SSL, SSH and SFTP for secure connection and data transfer. IT administrators can host websites on the Turbo vNAS and only allow access via HTTPS (SSL over HTTP) secure channel.



The best solution for secured communication : VPN + proxy server

Virtual private network (VPN)

Virtual private network (VPN) offers secure connections to access network resources and services across a public network. VPN offers a convenient solution for users to build end-to-end encrypted tunnels to your Turbo vNAS. The built-in VPN function in the Turbo vNAS supports two different configurations : a VPN server, which allows clients to securely connect back to the Turbo vNAS, and a VPN client, which allows a Turbo vNAS to connect to another Turbo vNAS across a WAN. When the Turbo vNAS acts as a VPN server, employees or users can access enterprise IT resources remotely through their mobile devices such as smartphones and tablets. Furthermore, they can also access websites that may be blocked in their network environment through the VPN service.

Turbo vNAS As a VPN Server

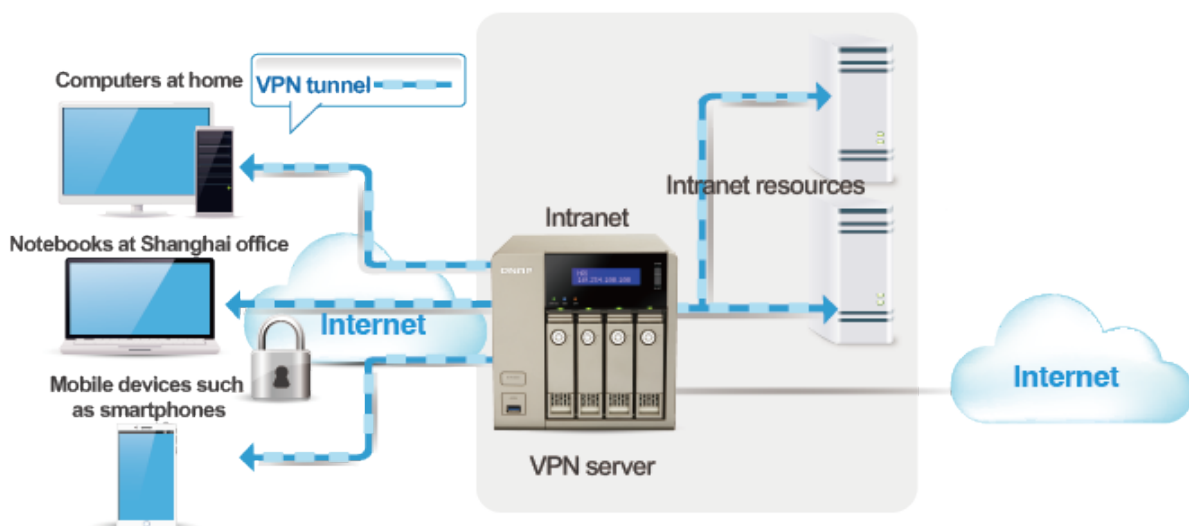

QTS 4.1.2 OS

When the Turbo vNAS acts as a VPN client, VPN can better protect your data when you use services like BitTorrent and eMule. By using this type of configuration, you can set up remote site backup with secure data transmission.

Turbo vNAS As a VPN Client for File Download

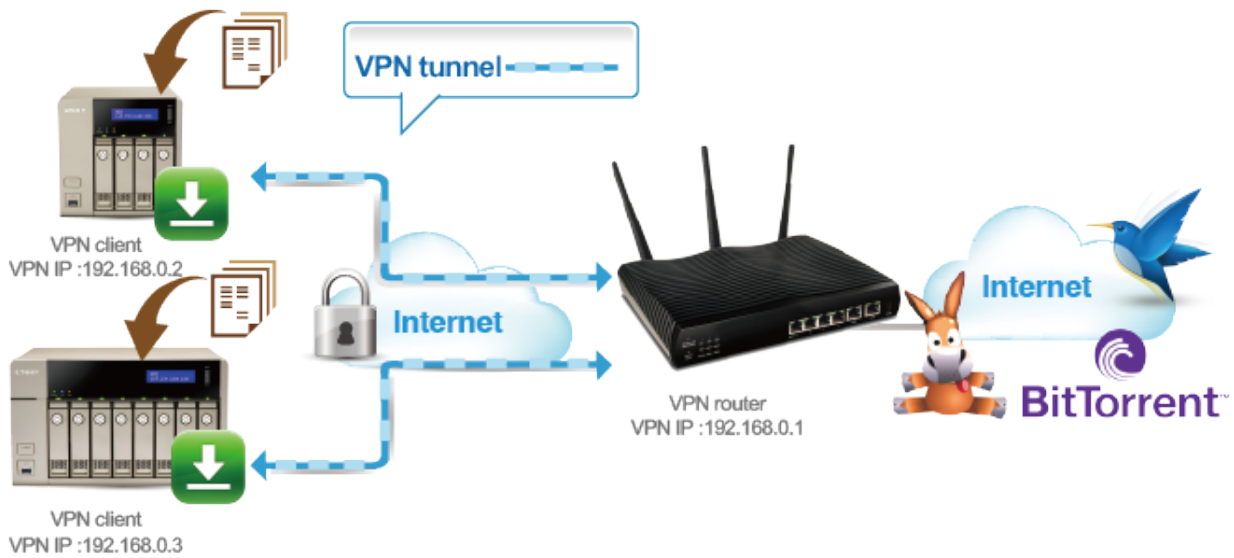

Turbo vNAS As a VPN Client for Off-site Backup

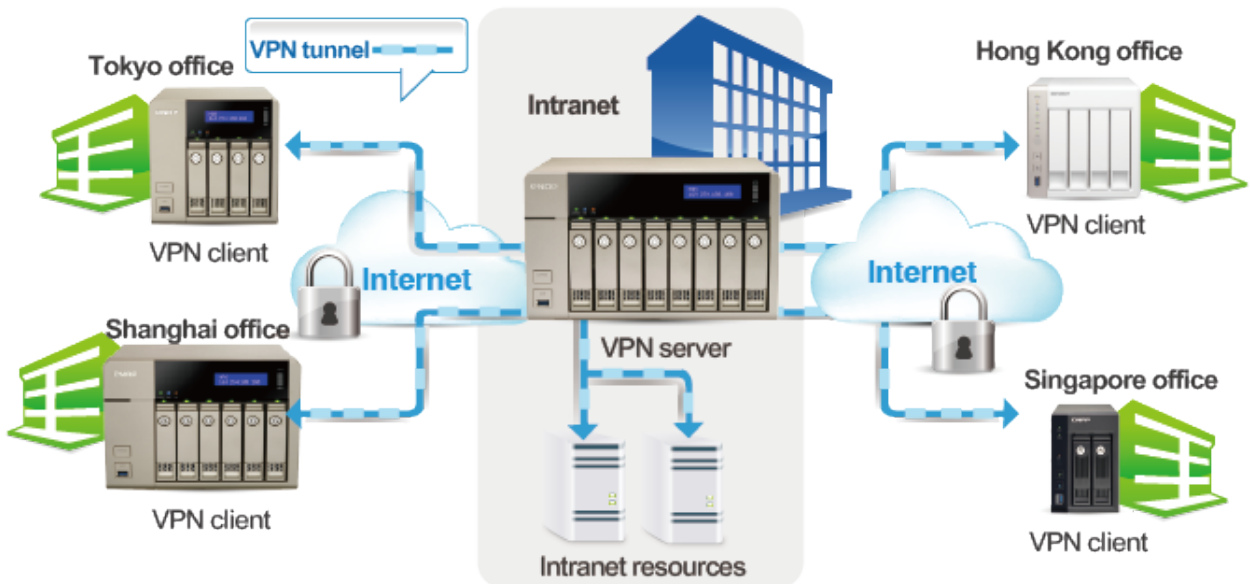

Squid : the popular web proxy server

The web proxy server provides cache and connection control for Internet services like HTTP and FTP. For companies that need a boost to web response time and security, Squid can be leveraged to make your Turbo vNAS a web proxy server to protect other devices in your local network from Internet attacks.

- Caching : Improves response time and saves bandwidth required for web access by caching visited web content and other web resources.
- Access Control : blocks access to certain websites or restricts access for internet connections.
- Logging : logs visits to web sites for generating statistics to aid in network management.
- Load balancing : distributes the load to several web servers to accelerate service requests.

Turbo vNAS As a Proxy Server for Access Control

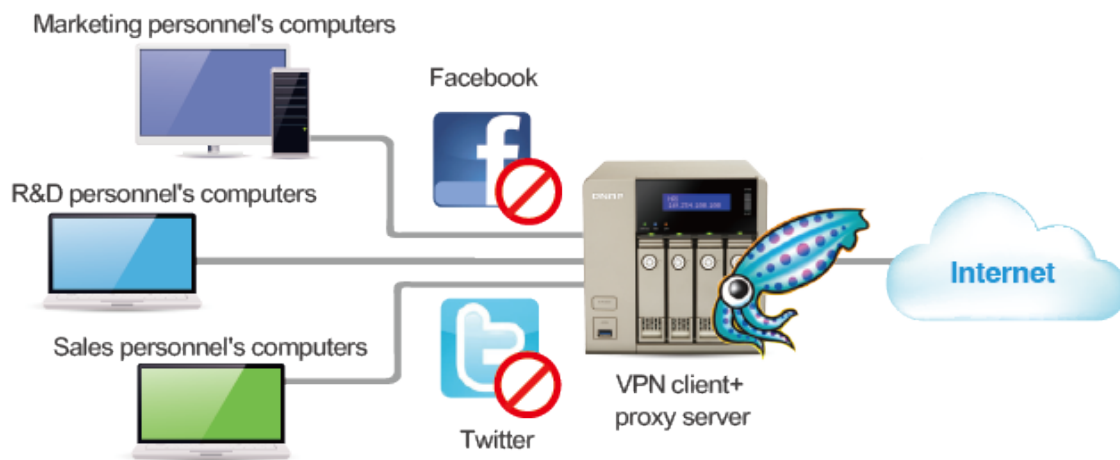

Case study for VPN+proxy services

Company X decided to open an overseas branch to expand its sales. In a fast-paced, competitive business environment, it is more important than ever to keep your employees connected to the people and resources they work with every day. Hence, the management team of this company required using networking technology to reach this goal.

The IT personnel of Company X found that a QNAP Turbo vNAS is easy to set up and use. It not only provides everything needed for data storage and backup, but also offers VPN and web proxy services for network access to employees in the main office, as well as at home and branch offices. Furthermore, the consumption of bandwidth is minimized and web access experience improved by using the web proxy function offered by Squid on the Turbo vNAS.

Now, the employees of Company X can enjoy secure, high-speed connectivity to the Internet and their business networks—both inside and outside the office to efficiently attain product information as soon as it is announced. Also, the IT personnels can set up scheduled backup from branch offices to the HQ for peace of mind.

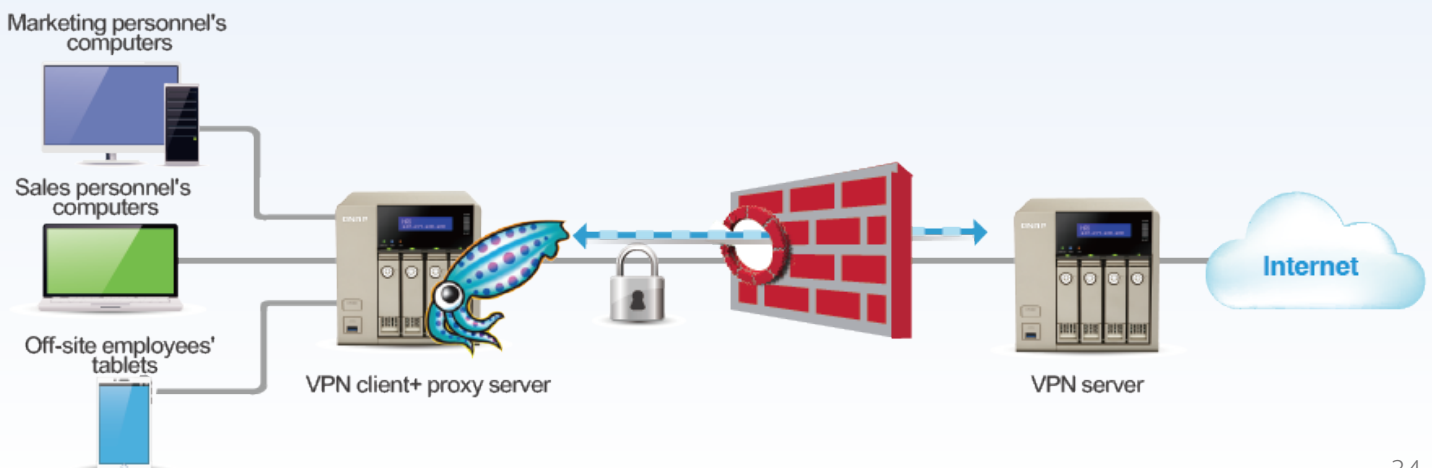

Uninterruptible Power Supply (UPS)

Activate the UPS support to ensure the Turbo vNAS is properly shutdown if power fails. In the event of a power failure the Turbo vNAS will shut down automatically or enter auto-protection mode by probing the power status of the connected UPS unit. You can set up the function by clicking QTS [Control Panel] > [System Settings] > [External Device] > [UPS].

■ Case study for NAS connecting to a USB UPS

You can set the Turbo vNAS to shut down or enter auto-protection mode if the power fails, and determine the action after few minutes of the power failure. Once the auto-protection mode is activated, the Turbo vNAS will revert to the state before power failure and continue to operate when the power restores.

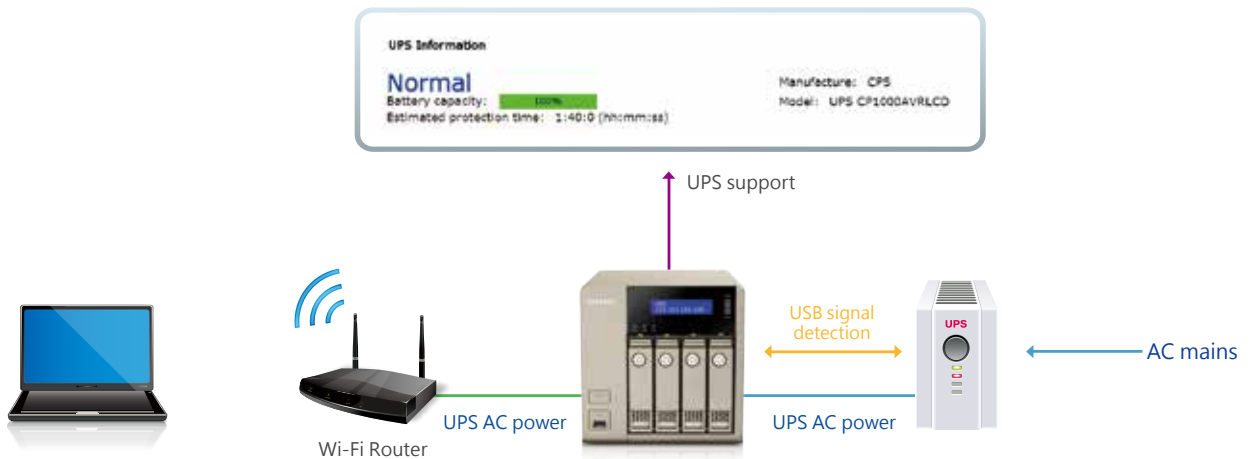

■ UPS with SNMP management

When the Turbo vNAS and the SNMP-based UPS server connect to the same network, you can select [SNMP connection] and enter the IP address of SNMP UPS server to set up the power failure notification.

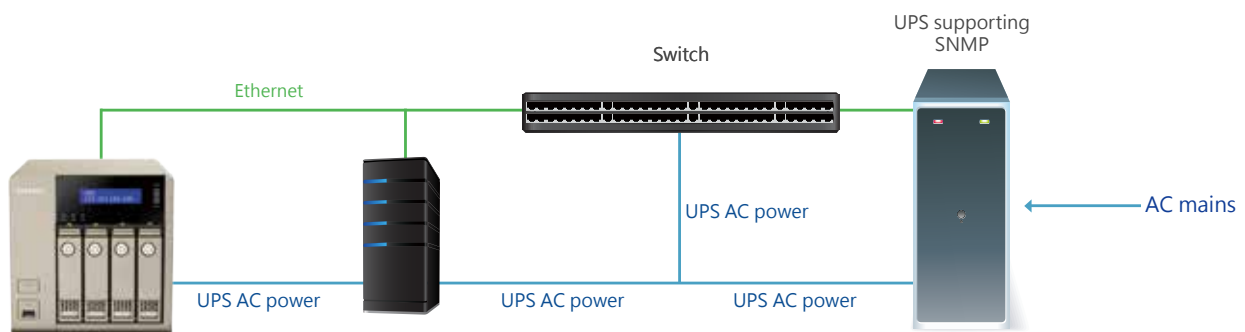

Multiple NAS units share an USB UPS

The network UPS "master" is connected to the UPS via USB cable. If the power fails, the UPS sends a notification to the network UPS "master" via USB and all the UPS "slaves" are informed by the UPS master via Ethernet. To set your Turbo vNAS as a UPS "slave": connect the UPS and the Turbo vNAS by USB, select [Network UPS slave], enter the IP address of the master server, and the slave server will get notification hen the power fails.

Step 2 :
Enter the IP address of the master server

Step 1 :
Select "Network UPS slave"

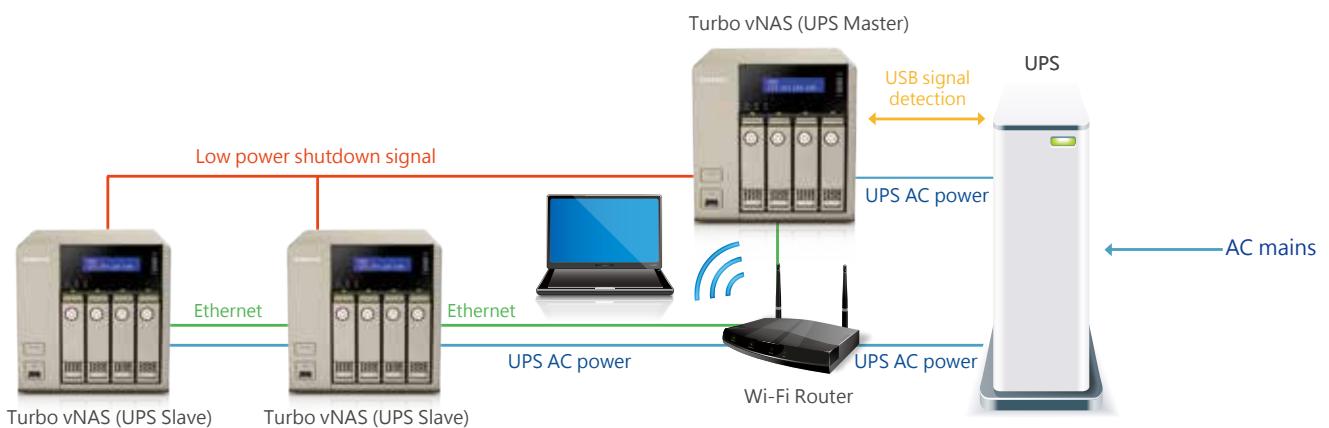
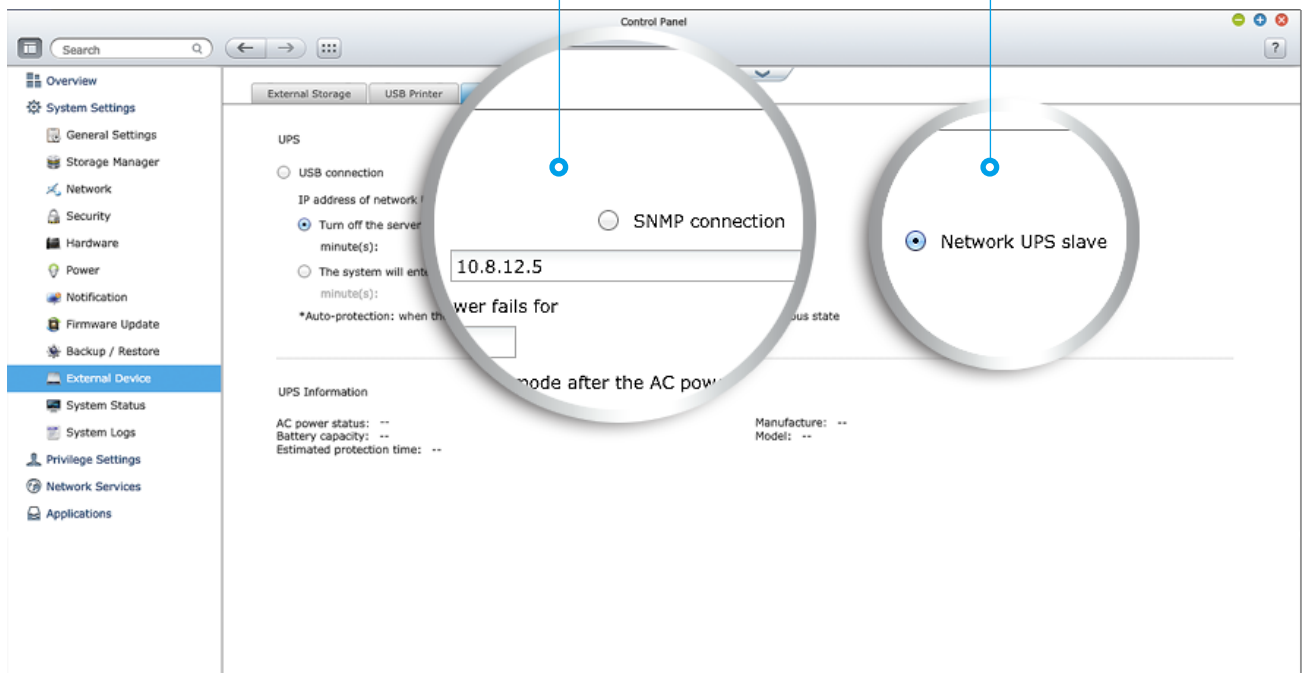

myQNAPcloud SmartLink



With the myQNAPcloud service it is easy to create a private cloud for enjoying your Turbo vNAS services safely and conveniently.

myQNAPcloud ID (QID)

Access your Turbo vNAS by signing into your myQNAPcloud portal (www.myqnapcloud.com) with your "QID" : a unique ID for you to access your Turbo vNAS and securely share your private data and files.

Publish and share

myQNAPcloud is an easy-to-setup service that simplifies the steps in publishing Turbo vNAS content over the Internet. On QTS myQNAPcloud, you can select numerous web-based Turbo vNAS services, such as Photo Station, Music Station, and File Station to be published to the myQNAPcloud.com website. Likewise, you can easily view friends' public services on the myQNAPcloud.com website too.

Web-based file management

The myQNAPcloud portal enables you to manage multiple Turbo vNAS units in one place. With the easy-to-use management interface, you can simply download, move, and copy files on your Turbo vNAS, lessening the difficulty in accessing multiple Turbo vNAS servers. All you need is to sign into myQNAPcloud.

Trustworthy file protection

To ensure the security of remote access service, myQNAPcloud strengthens keys on SSL Certificates to 2048-bits. The files on the Turbo vNAS are 100% under the NAS owner's control.



myQNAPcloud Connect

myQNAPcloud Connect application is designed for Windows® PC users. By installing the myQNAPcloud Connect, users are able to connect to the Turbo vNAS and easily manage files by dragging-and-dropping within Windows® Explorer.





▪ CloudLink for easy remote access

myQNAPcloud features the new CloudLink App (QPKG) for an easier remote access experience. Without any complex router settings, all you need to do is install the app and login with your myQNAPcloud ID (QID), then you can access to your Turbo vNAS through the myQNAPcloud.com website. CloudLink will automatically choose the best way to connect based on your network environment. CloudLink supports access to the Turbo vNAS via mobile devices with the Qfile/Qmanager apps or via computer with the Qsync utility. Visit the QNAP App Center to download the CloudLink App (QPKG), and experience the new myQNAPcloud Smart Link remote access service.

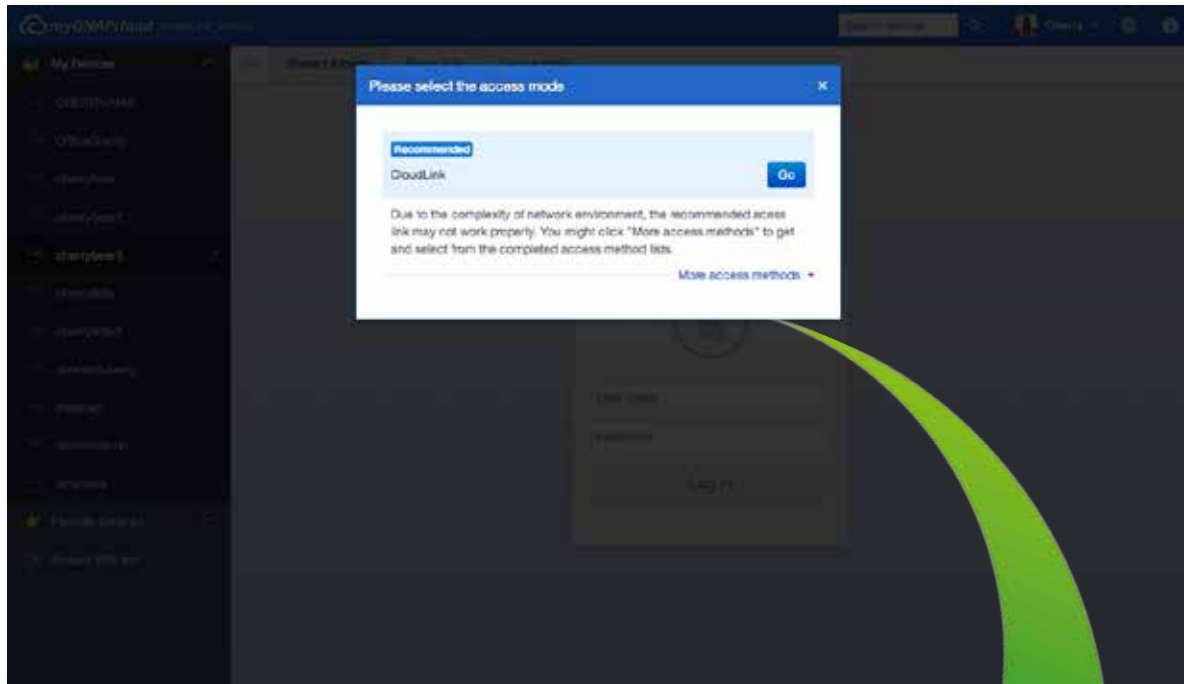



Qsync : A Powerful Utility for File Synchronization

Public cloud files synchronization services such as Dropbox can greatly increase the efficiency and productivity of offices, but comes with certain drawbacks :

1. Security : there is the possibility of data leaks and interception of confidential information.
2. Cost : the greater the size of your data storage needs, the greater the cost of the service.



With QNAP's Qsync utility on Turbo vNAS, IT administrators can create a Dropbox-like private cloud with a larger storage capacity to fulfill business needs. Any files added to the Qsync folder will be automatically accessible across multiple devices, and synchronized with different work groups flexibly and effortlessly. With no additional costs or storage limits, Qsync can centralize files from different work groups and assist in teamwork on important projects anytime, anywhere.

■ 7 reasons why you need Qsync

1. Cross-device synchronization

Qsync turns your Turbo vNAS into a safe data center for files synchronization. Every file uploaded to the Qsync folder will be made available to multiple devices including computers, laptops and mobile devices. When you are away on a business trip, Qsync ensures that the most up-to-date files are accessible on all linked devices and reduces your need to rely on USB storage to carry files and on emails to get the latest files.



Synchronize with Windows®

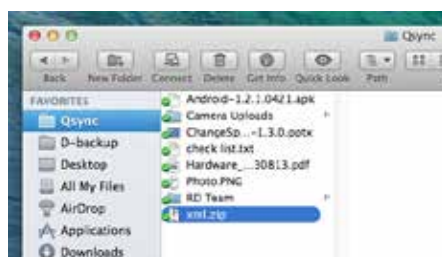

Synchronize with Mac



Synchronize with iPhone/Android smartphones via Qfile. Synchronize with iPad via Qfile HD

2. Intelligent offline editing

You can edit your files offline and once your device is online, Qsync will automatically sync them. This offline editing feature ensures your files are protected without any information loss.

3. Flexible synchronization methods

Qsync has many sync settings to prevent taking up significant storage space on your computer. With both Full Sync and Smart Sync options, you can choose to synchronize all the files in the Qsync folder or you can enable the Smart Sync option to remove local files without affecting the centralized files stored on your Turbo vNAS.

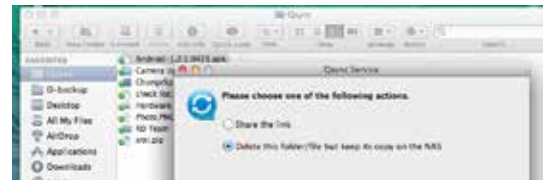

4. Share files & folders more efficiently

You can create sub-folders within the Qsync folder, share each with different work groups and everyone with the same sub-folder is always kept up-to-date with the latest files. All your files are shared via drag-and-drop. With Qsync, your Turbo vNAS becomes an aggregative data center and greatly enhances teamwork flexibility.

5. Auto-upload from mobile devices

You can enable the auto-upload option on the Qfile mobile app and automatically sync your files to multiple devices. Your meeting minutes, notes, and seminar recaps will be automatically uploaded and synchronized as well.

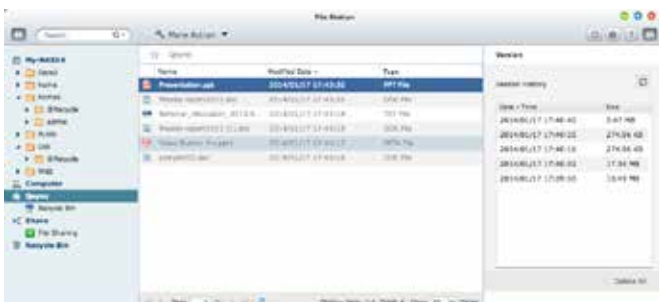

6. Integrated version controls protecting against accidental deletion

The Turbo vNAS will retain up to 64 versions of files when they are modified, allowing you to retrieve a specific previous version at any time. Even if you have accidentally deleted the file you can restore previous versions from the recycle bin. With capacity-efficient restoration, the reserved version only keeps the changes made to the file and assists in optimizing your storage space.

7. High security

Qsync can create a private cloud within your intranet and benefit from your existing secure network environment. The Turbo vNAS also supports HTTPS connection assisting in creating a safer, more reliable business network environment.

Mobile apps & utilities



Share Files with Mobile Devices

You can install the Qfile app on your mobile device to browse and manage files stored on your Turbo vNAS anytime, anywhere.

▪ Qfile



Access from anywhere

Open Qfile on your mobile device to browse files on the Turbo vNAS. You can open or share files, and easily rename, copy, move, download any selected files.

Stream multimedia contents

Browse and play the music, photos and videos on the Turbo vNAS. No more worries about the space limitation of your mobile device.

Auto-upload photos

Automatically upload photos to your Turbo vNAS whenever you take new photos. It works as a real-time backup of your precious photos.

Offline file reading

Download documents, photos or music from the Turbo vNAS to your mobile devices for offline reading.

Folder & file sharing

Create download links for shared folders or files to share via email or SMS. You can also share by email as attachments.

▪ Vmobile



Mobile surveillance with ease

Vmobile is a professional surveillance mobile app for remotely managing the Surveillance Station of linked Turbo vNAS or the IP cameras of VioStor NVR.

More advanced functions

Besides real-time monitoring, the VMobile allows you to remotely control the recording, snapshots, and playback. Once alarm events occur, an instant notification is also provided.

▪ Qmanager



Manage multiple NAS units

Add multiple Turbo vNAS units on Qmanager, and conveniently manage anyone of them anytime and anywhere.

Monitor system status

Monitor your system information, such as CPU usage, memory usage, system event information online users, etc. You can also check connection status to prevent suspicious invasion.

Remote management

With one click, you can use Qmanager to turn on/off or restart the Turbo vNAS, open or close Turbo vNAS services, and set up Wake on LAN.



Utilities

Work efficiently and manage the Turbo vNAS smartly with the various easy-to-use and practical utilities.

Qfinder

Qfinder is available for Windows®, Mac, and Linux users to quickly find and access the Turbo vNAS over the LAN. You can also update the firmware or set up Wake on LAN through the Qfinder.

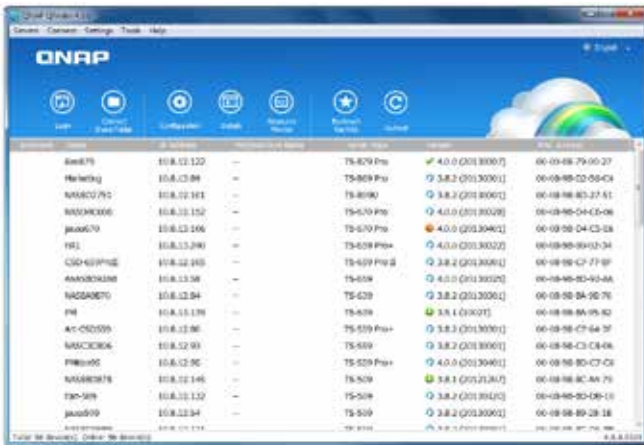

myQNAPcloud Connect

myQNAPcloud Connect is designed for Windows® PC users to connect to the Turbo vNAS and easily manage files by drag-and-drop within the Windows® Explorer.



Qsync

Qsync provides cross-platform synchronization. It creates a specific “Qsync folder” in your devices that you can simply drop files in, and synchronizes the files to all your devices linked to the Turbo vNAS.



NetBak Replicator

QNAP NetBak Replicator helps you easily back up files or the entire hard drive data from Windows® PC to the Turbo vNAS. It also supports backing up to a remote server via FTP and WebDAV through the Internet.

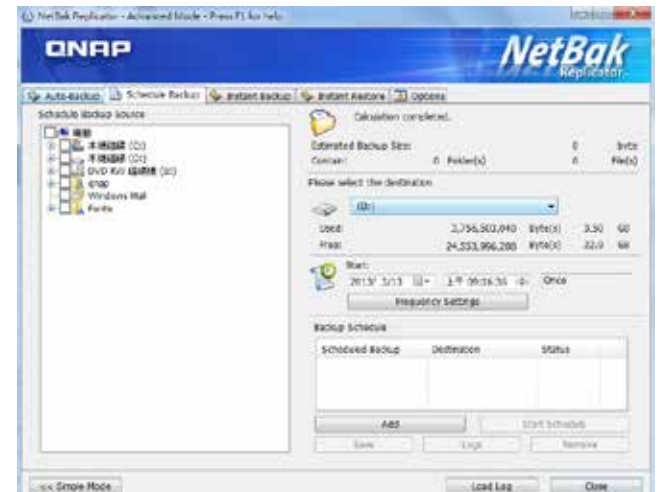



QNAP's Unique Transcoding Technology

Every year many SMBs produce hundreds of promotional videos for marketing purposes. However, due to the increasing use of HD videos (720p, 1080p), video files are becoming increasingly large in size and can use lots of network bandwidth to share or play them over a network.

Powerful transcoding tools

On-the-fly transcoding and background transcoding allow you to convert videos to optimized resolutions for accommodating slower/restricted network environments and device limitations.



Smart transcoding adapts to suit different bandwidth

The TVS-x63+ series provides a range of resolutions to play/share videos according to different bandwidth limits. Higher resolutions need more bandwidth, and you can select the right resolution for your network environment to get the best viewing experience.

Resolution \ Network	240p	360p	480p	720p	1080p
Ethernet					
Wi-Fi (108.11 ac)					
Wi-Fi (108.11 a/b/n)					
4G (LTE)					
3G					

▪ Multi-mode transcoding function

Background hardware-accelerated transcoding

The TVS-x63+ series fully supports offline background transcoding for 1080p videos. Just add videos to the transcoding list and use the Turbo vNAS to convert the original high-resolution video for use with multiple resolutions. Then you can select an appropriate resolution when sharing or watching to match your device or network environment.

Auto transcoding

When you set a folder on the Turbo vNAS to be an auto-transcoding folder, videos added to it will be automatically converted to a resolution you have set. For example, if you set the folder to 360p, videos added to this folder will be automatically transcoded to 360p as a background task.

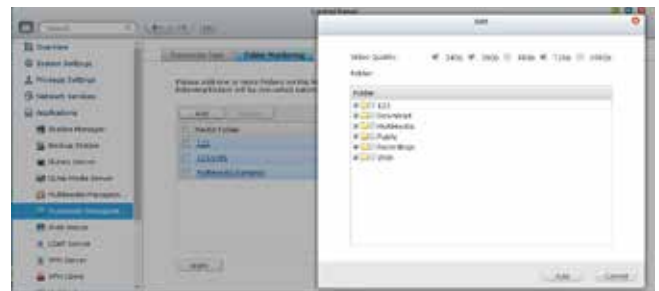

On-the-fly transcoding

If you have many high-resolution videos, but did not transcode in advance, you can use on-the-fly transcoding. This will adapt to meet bandwidth limits, with the Turbo vNAS transcoding in real time for directly watching the video.



Subtitles

By selecting the Embed Subtitles option in the Transcode Management function, you can embed subtitles to a video when converting a video to any resolution. The subtitles will then be displayed when a video is played on whatever device you are using.

Hardware-accelerated transcoding technology

With powerful AMD® Radeon™ Graphics, video creation & conversion is faster, easier and can significantly reduce the time needed when handling concurrent on-the-fly transcoding tasks.

QNAP Turbo vNAS transcoding videos day and night

According to surveys, in a typical SOHO environment the Turbo NAS is idle for more than 60% of the time. To make the most of this idle time, you can set the Turbo vNAS to transcode videos after office hours. This way you can watch videos later or share them immediately on your computers and mobile devices.



Virtualization Applications

Unified storage and virtualization applications

The Turbo vNAS supports iSCSI & NFS protocols and is virtualization ready with compatibility for VMware®, Citrix®, and Microsoft® Hyper-V to provide businesses with powerful & flexible storage solutions for virtualization applications.



- **Virtualization ready**

The Turbo vNAS supports VMware® Ready™ vSphere 5 and VAAI; Citrix® XenServer 6.0, and is compatible with Microsoft® Hyper-V, supporting ODX and Windows® Server 2012.

- **VAAI/Hyper-V Plug-in Support**

Use the free QNAP vSphere Client plug-in and QNAP SMI-S provider for SCVMM and managing the Turbo vNAS from the virtualization management client console is easy.

- **Secure and flexible storage utilization**

The Turbo vNAS offers flexible management through creating and allocating iSCSI LUNs (Logical Unit Numbers), mapping and unmapping LUNs to and from iSCSI targets, and thin provisioning. CHAP authentication and LUN masking support reinforces secured deployment in virtualization applications.

- **NAS/IP SAN unified storage**

QTS supports NFS and iSCSI/IP-SAN storage solutions that can be utilized as network-shared storage of virtualized environments, helping to achieve an efficient cost-saving, energy-saving optimized storage capacity.

■ **VAAI for iSCSI, VAAI for NAS**

The QNAP Turbo vNAS, VAAI iSCSI and VAAI NAS are VMware certified. Businesses can select either iSCSI or NFS as a centralized storage to boost performance. VAAI for iSCSI supports Full Copy (hardware-assisted copy), Block Zeroing (hardware-assisted zeroing), Hardware-assisted Locking, and Thin Provisioning with space reclaim. VAAI for NAS supports Full File Clone, Extended Statistics, and Reserve Space. The QNAP Turbo vNAS supports VAAI iSCSI and VAAI NAS to enhance storage performance in a virtualized environment.

QNAP Turbo NAS: Boosted Performance by ODX

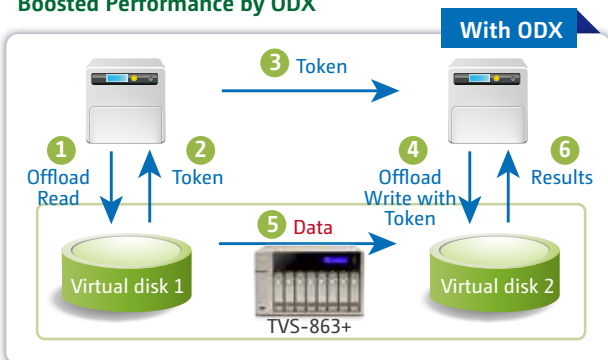

Other NAS

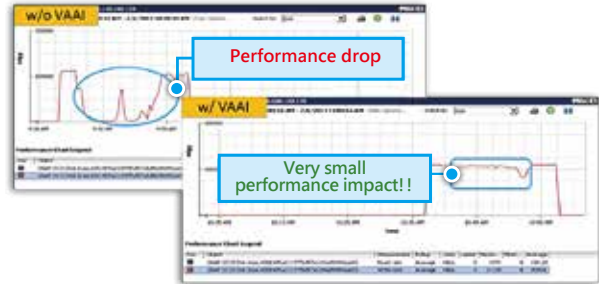
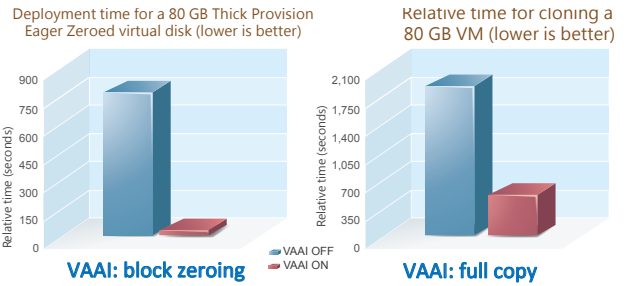
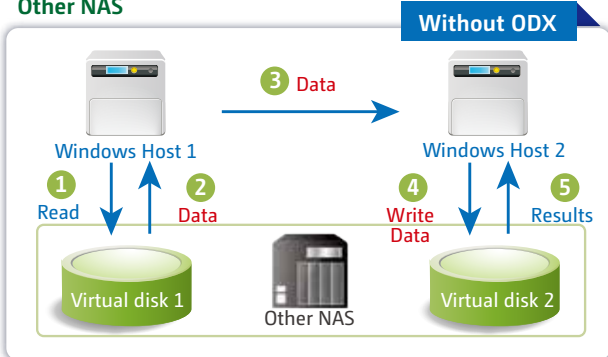

VAAI: Hardware-assisted Locking

■ **Storage for Microsoft Hyper-V**

With ODX support, the QNAP Turbo vNAS becomes a high-performance iSCSI solution under Windows® Server 2012, including Hyper-V virtualized environments. QNAP storage enables full copies of virtual machines within the NAS without requiring the Windows® hosts to read and write the data to highly reduce the load on Windows® hosts and improving the performance of copy & move operations on Windows® 2012 hosts. When providing QNAP storage to a Windows® 2012 file server, the end user using a Windows® 8 client workstation will also benefit from the Offloaded copy process for large file transfers.

■ **NAS management via SCVMM**

QNAP SMI-S enables management of the QNAP Turbo vNAS directly through Microsoft System Center Virtual Machine Manager 2012 (SCVMM)



■ **vSphere plug-in**

The vSphere plug-in allows users to manage the QNAP Turbo vNAS directly on the vSphere client, making datastore management more effective.

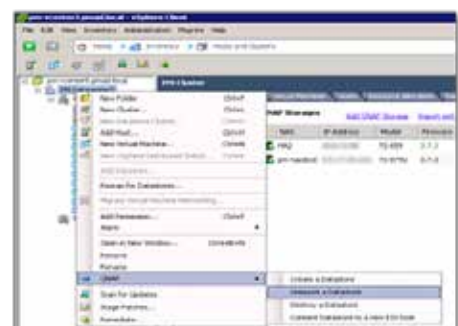

5 Major Applications for Businesses

Multi-purpose Workstation for Business IT Environment

1

Backup Station



Protecting against potentially disastrous data loss is of paramount importance for all sizes of businesses from micro to enterprise. QNAP Turbo vNAS offers an all-inclusive backup and recovery solution with enormous storage capacity and superior transmission speed. With the functionalities in the backup station, data backup and recovery is simpler and more powerful regardless of your business's disaster recovery plan.

■ All-inclusive data backup and disaster recovery

1. PC backup

Windows® users can install the free QNAP NetBak Replicator utility to back up files from Windows® PC - entire disk drives, documents, pictures, music, videos, fonts, emails, and more - to one or multiple Turbo vNAS units. With simple clicks, you can set up real-time backup, scheduled backup and auto-backup. You can set power off after the backup is finished to save energy; file filtering to exclude files not to back up; and email notification when backup is completed.

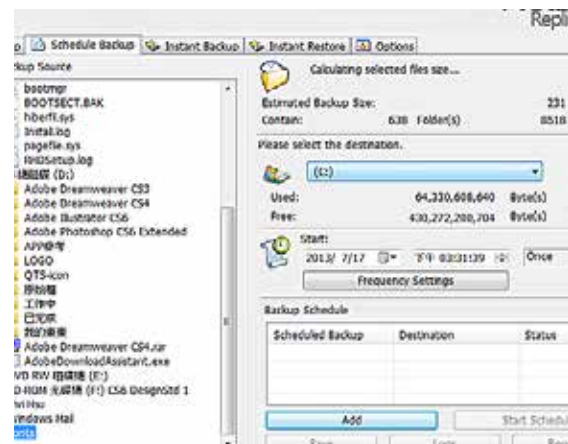

2. Mac backup

Mac users can use the Mac Time Machine to back up data to the Turbo vNAS. You only need to set the Turbo vNAS as the backup destination on the Time Machine management page, and it's done.



▪ Back up data on the Turbo vNAS for disaster recovery



1. Local backup to external storage devices

Connect an USB device to one of the USB ports. Log into the QTS and go to “ Control Panel”>”Applications”>”Backup Station” and create a job with the External Backup function.

2. Remote backup with RTRR/rsync services

- Use rsync protocol to execute scheduled backup to remote rsync server.
- Use RTRR (Real-Time Remote Replication) services for real time data backup to a remote Turbo vNAS or FTP server.
- Use RTRR to sync shared folders between two Turbo vNAS units.

3. Cloud backup to cloud storage

Users can back up the data from the Turbo vNAS to online cloud storage services, such as Amazon® S3, Amazon® Glacier, Microsoft® Azure, Google® Cloud Storage*, IBM® SoftLayer, HP® Cloud, Rackspace®, ElephantDrive®, hicloud S3, and CCIS. The Turbo vNAS also supports other types of cloud backup using S3, OpenStack Swift, WebDAV, or FTP service. Furthermore, Turbo vNAS provides advanced functions such as data encryption, compression, download/upload rate control and scheduled backup to suit your backup needs.

*Google® Cloud Storage will be available soon in the App Center for download.

Tap on the “Copy” button near the USB port on the front panel of the Turbo vNAS to instantly back up data to the NAS.

2

IT Management Station



Powered by Mandriva® Pulse, IT Management Station is designed to simplify daily tasks and IT asset management for businesses of all sizes. Your Turbo vNAS becomes an IT system management server to help you centrally manage multi-OS & multi-site IT resources, applications and security with greater flexibility.



At the core of Pulse



Comprehensive Inventory
Pulse automatically retrieves hardware & software information from your IT system using an inventory agent to provide you with reliable and timely data. It measures the potential of your inventory and runs your IT assets tactfully, thanks to dynamic groups, which are self populated from queries.



Cloning
As part of a scheduled or on-demand restoration, systems and their stored data can be fully backed up easily.



Deployment
Design, schedule and implement software installation on your IT assets.



Mastering
Create generic disc images to carry out mass OS deployments.



Backup and restore
Save time, optimize storage and protect data from accidental loss using incremental backups.



Remote control
Help your users in their everyday tasks by connecting from remote locations without compromising the security of their IT assets..

■ New features in Mandriva Pulse 2.0

Reporting

Create and edit reports/graphs for better control of your IT assets and to anticipate future changes.

Pull mode

Increase the compliance of your roaming devices for deploying packages needed in any environment.

License management

Optimize your software assets with an overview of used and available licenses.

Update management

Centralize your software updates for greater control and security.

Software convergence

Efficiently deploy software using an automated process.



■ Flexible management of your IT assets

Multi-OS

Manage all your IT assets and virtual machines no matter if it is Windows®, GNU/Linux, Mac or Unix.

Multi-site

Remotely & securely manage your sites via SSH tunnel, simultaneously controlling the bandwidth and conserving the availability of your network.

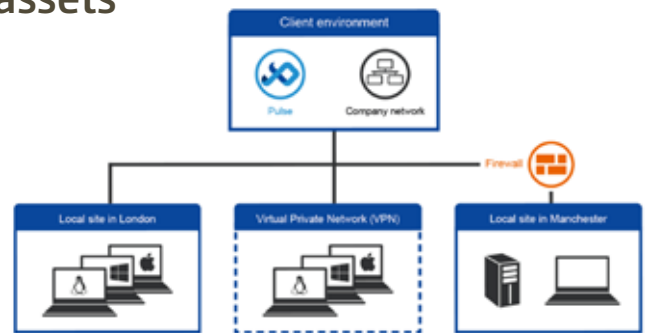

■ Intuitive tools

Features a desktop icon for quick self installation to facilitate access and remote control of new deployments.



A simple web interface with an intuitive dashboard for quick information regarding your IT assets.

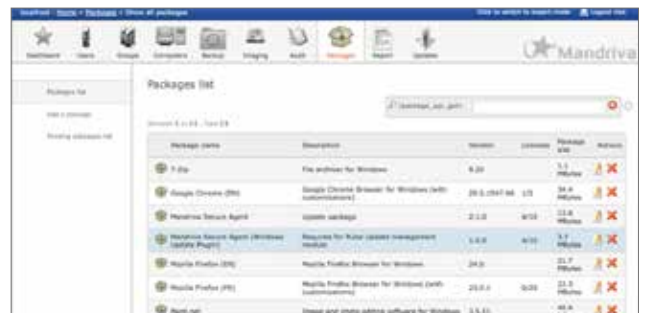

A unique management interface for software licenses and automatic package management.



3

Surveillance Station



One of the standard Turbo vNAS applications, the Surveillance Station is professional network surveillance Video Management System (VMS) that can be activated in the QTS App Center to turn the Turbo vNAS into a professional Network Video Recorder (NVR) system for real-time monitoring, recording, playback, alarm notifications, Intelligent Video Analytics (IVA), and management to safeguard your assets and property when used with supported IP cameras. The TVS-x63+ series comes with 4 free camera channels, allowing users to easily build a surveillance system.



4 free camera licenses

Professional NVR system

Wide range of supported IP cameras

Surveillance Station is compatible with over 2,700 IP camera models across over 90 brands and ONVIF specifications, including those that support advanced features such as multi-streaming and fisheye dewarping.

Expandable license management

TVS-x63+ series offers 4 free IP camera channels and can be expanded to 40 channels to fulfill various surveillance deployment needs.

Cross-platform support

Surveillance Station works with all major web browsers including Google Chrome, Mozilla Firefox and Internet Explorer. With the QNAP Surveillance Client for Mac, users can enjoy a similar experience on their Macs.

Advanced storage technology protection

Surveillance Station is installed on the Turbo vNAS platform and is protected against loss, theft, and damage of recorded videos with the help of advanced security features and RAID technology.



Live-view

Various remote monitoring modes

The Surveillance Station supports various monitoring modes to display up to 64 channels on a single screen. Users can also choose to sequentially display each channel or use dual displays for more information.

PTZ (Pan/Tilt/Zoom) control

On the Surveillance Station web interface, you can directly adjust the PTZ (Pan/Tilt/Zoom) functions of supported cameras, greatly enhancing the convenience in remote monitoring.

Instant playback

On the Live-view page, whenever you want to check suspicious events of a camera channel you just missed, just hit Instant Playback to bring up the window to review recent events.



Visual aid by E-map

Just upload pictures of monitored locations to the Surveillance Station and drag & drop the IP camera icons to them on the E-map. Once an alarm event happens, the camera icons will flash to indicate the event type for you to be immediately alerted to take necessary actions.

Instant notification

When alarm recording is enabled and an event occurs, an alarm icon will be instantly shown on the monitoring page. The alert details can be viewed by clicking the icon.



Please note: You can also use USB webcams for Surveillance Station to record videos. Just install the QUSBCam App on a Turbo vNAS from the QTS App Center to assist in building a small surveillance system for your office with USB webcams.

Business Solutions

Playback

Preview recordings by thumbnails

You can move the mouse cursor over the timeline to preview video thumbnails to quickly identify and search for events. No need to play the video from the start and wait.

Intelligent Video Analytics (IVA)

IVA is an advanced way to quickly search videos corresponding to particular modes, greatly saving the time & effort of manually screening out matching videos. IVA includes motion detection, foreign/missing objects, out-of-focus and camera occlusion.

Real-time watermarking

The support of digital watermarking assists in verifying the authenticity of exported videos and snapshots by showing the exact recording date & time, camera name, and Turbo vNAS model name, making it essential when videos are needed as verifiable evidence.

Playback and speed control by shuttle bar

With the speed control shuttle bar, you are able to fast forward playback by dragging the button to the right and to the left to rewind, helping you quickly find the desired screenshots.





Flexible management

Flexible camera access control

You can create up to 32 user accounts on the Surveillance Station and flexibly assign them to different user groups with different rights for monitoring, playback, PTZ control, and audio monitoring.

Advanced event management

The system starts alarm recording when alarm events occur. Administrators can configure events and assign 7 types of event actions to ensure that they are alerted immediately, including recording, PTZ Control, alarm output, email notification, SMS notification, buzzer notification, and user-defined actions.

Manage large-scale cameras

By connecting multiple Turbo vNAS units, you can simultaneously manage, monitor and playback up to 128 IP cameras with one Turbo vNAS.

Mobile apps

VMobile – Surveillance at anytime, anywhere

VMobile allows you to monitor the Surveillance Station anytime, anywhere using iOS and Android devices. It provides camera live-view, PTZ control, instant event notifications, video snapshot, video playback, and searching videos by date and time.



Vcam – Turn your mobile device into a camera

Vcam turns your mobile device into a network camera. With the Vcam mobile app, you can record any moment around you to your Turbo vNAS, saving the need in buying expensive IP cameras.



4

Signage Station



The Signage Station is a free Turbo vNAS app that allows businesses to create attractive menu boards, advertising posters, and business profiles and easily publish them to monitors and tablet devices to attract more customers.

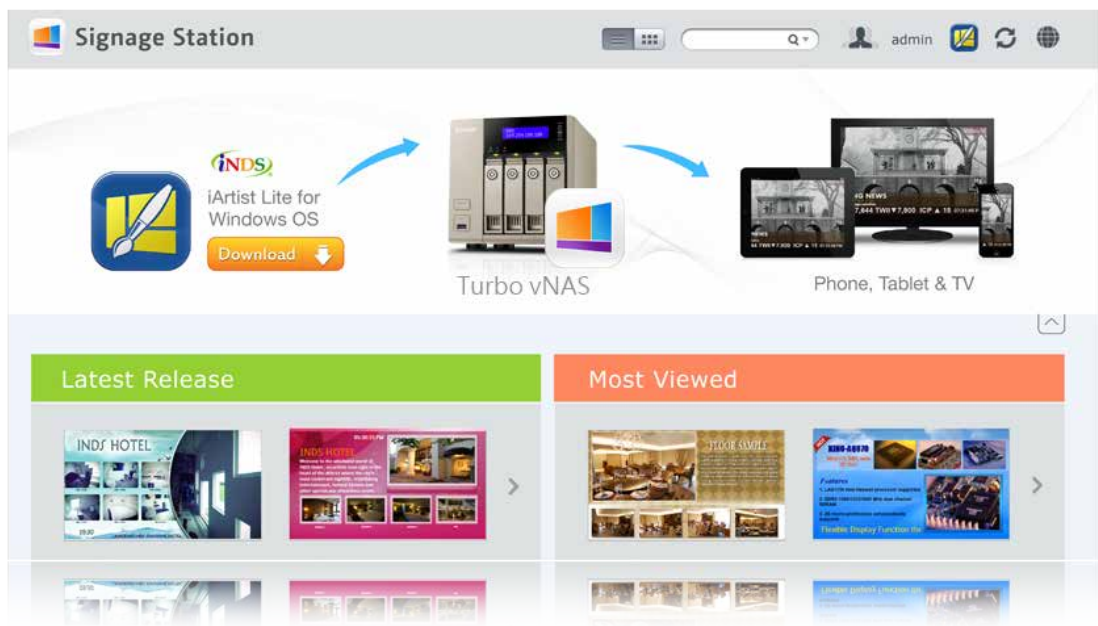

Drive business growth and increase revenue

Your content can be presented on a web browser and when on the go, and you can even show your profile, business card and product catalogs on mobile devices and share on Facebook. The Turbo vNAS with the Signage Station is an ideal tool to present creativity and drive business growth.

Absolutely easy-to-use

iArtist Lite provides a drag-and-drop interface that allows you to flexibly embed videos, marquees, pictures, and PowerPoint slides on the canvas panel. With the layered playlist and timeline features, you can freely arrange the order of media objects. iArtist Lite also offers numerous templates for various scenarios, saving you lots of time & effort. Useful widgets such as audio, clock, RSS are also available to add to the designed content.

Instantly publish and conveniently revise

With iArtist Lite you can save your designs as different projects and upload them to multiple Turbo vNAS with Signage Station installed. Whenever you want to revise the content, just open iArtist Lite to update and publish instantly. You can fully control all your content in a timely way.

Collaboration increasing efficiency

The original content can be saved on a local computer or the Turbo vNAS with the help of the connection wizard. Content saved on the Turbo vNAS is accessible for every authorized user to increase the work efficiency in projects involving multiple members.



iArtist Lite

Create You Advertising Content Easily

How to make advertising content on iArtist Lite?

The concept of dynamic multimedia content is quite simple: just drag & drop media files to the iArtist Lite canvas and arrange it as required. Choose the device that you want to display, such as tablet, HDTV or smartphone. After selecting the device resolution you can select whether to present it in portrait or landscape.

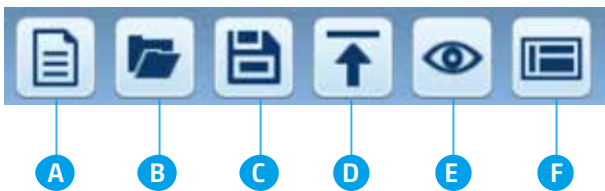

iArtist Lite functions :

- A** Add new content
- B** Open previous content
- C** Save content
- D** Upload to Turbo vNAS
- E** Preview design
- F** Online template support



Introduction of iArtist Lite tools :

- Video, photo, and music : Add the file to the canvas from Windows®.
- Digital & analog clock : Supports multiple types of clocks and formats, just drag & drop to canvas.
- Background image : Choose a background color or choose a background image.
- Mask : Add an image mask to the content.
- Text & banner : Edit the text on the banner you'd like to promote.
- RSS : Share an RSS link from a website to share messages.
- Digital menu board : Design a neat menu board, and edit the price and picture anytime, anywhere.
- Combo menu board : Select the template and add the price and picture.
- HTML : Drop a website on the canvas for the most direct promotion.
- PPT and PDF : Easily add documents to the canvas including slideshows, retaining the animations from the PPT.



Intuitive user interface with timeline view
 After dragging & dropping from the left panel to the canvas, each media file will have a corresponding timeline at the bottom of the canvas to allow users to easily manage their timing and placement.

5

Notes Station 2.0



QNAP has now leveraged its private cloud functionality to introduce Notes Station 2.0. It provides the convenience of notetaking on cloud-based services but with the privacy and security of Turbo vNAS. Users do not have to worry about risks from public storage, and are able to enjoy easier data access at all times.



Single workspace for all note taking activity

With its 3-level structure (Notebooks, Sections, and Notes), Notes Station 2.0 allows you to manage all your notes systematically and flexibly whether it is a note you write to yourself or for work. You can jot your valuable ideas in Notes Station 2.0 and keep them safely accessible through your own devices wherever you are.

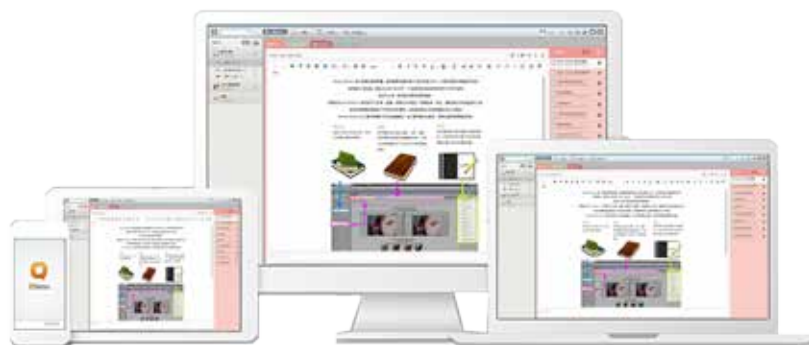

Powerful editing

Notes Station 2.0 is capable of advanced editing. You can style the text by changing the size, font, or color. You can also edit inserted images with the built-in photo editor to enrich your content.

Google Calendar support

The event in the Notes Station Calendar links to the note you created it from. You can update the calendar from Notes Station 2.0 to your Google Calendar with a single click, so you will be reminded for every event.

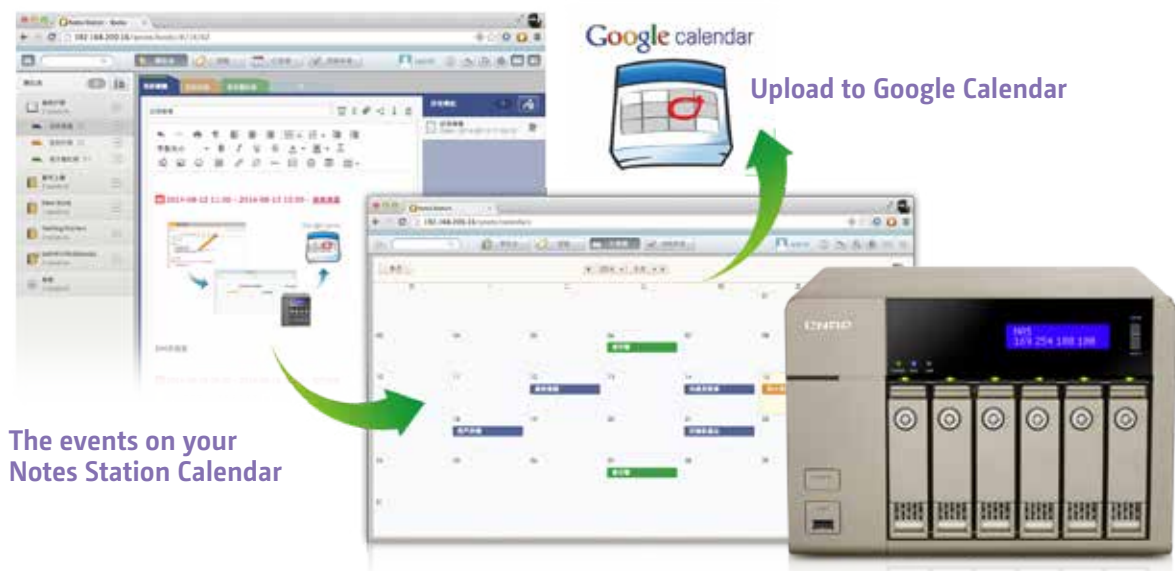

High-performance encryption

You can encrypt your notes with high-performance AES 256-bit encryption to protect against unauthorized access.



PDF import/export

Notes Station 2.0 can import PDF files into Notes Station 2.0, and export note files (i.e. Notes, Sections, Notebooks) to PDF files. When a notebook is exported, the sections and notes of the notebook transfer to the chapters and contents of a PDF file respectively, and vice versa for the import function.



Online preview

You can quickly view the attached files in PDF, Word or PowerPoint format online with Google Docs or Office Online. Other file formats such as photos, music and videos can be played instantly with the built-in programs.



RSS feeds import

If you have subscribed to RSS feeds from news websites or blogs, you can use Notes Station 2.0 to automatically import the published contents.



Notes sharing and collaboration

Notes Station 2.0 contributes to team work and networking. You can create a link for your notes and publish them on your social networks or share them through the apps on your smartphone. Thus, you can invite other people to work on the same notes.



Snapshot

You can use the snapshot function to back up different revisions of your notes. Your notes can be effortlessly restored to an earlier version. The QTS Snapshot is a great tool to record the state of a note at different time points. You can create up to 1,024 snapshots manually or by schedule and it is easy to retrieve files from a specific point in time if they are broken or mistakenly deleted.



Evernote backup

Notes Station 2.0 comes with an import function to restore backups from Evernote. In addition, you can directly access your notebooks in Evernote to import them online to Notes Station without exporting.



App Center & Development Platform

Add-on Values and Friendly Development Platform

The QTS App Center provides various apps for you to install on demand, enjoying more applications and increasing the value of your purchase.

Powerful and rich-in-content

The App Center provides over 100 apps, including backup/sync, business, content management, communications, developer tools, download, entertainment, surveillance and utilities.

Install on demand

Find what you need and install it immediately with just one click.

Upgrade reminder

If newer versions of your installed apps are available, an upgrade reminder will show on the QTS desktop to help you keep your Turbo vNAS applications up-to-date.



★ Most Popular Apps :

■ Gmail Backup



Gmail Backup provides Gmail backup and recovery functionality, allowing users to create individual backup or domain account backup tasks. Gmail can be backed up by schedule and the content previewed through a web management interface. Backed up mail can be restored to the original mail account or other accounts: just configure the restore account, enter the account and password and the user can restore mail to the specified account.



■ Google Drive Sync App



Google Drive is a cloud storage service provided by Google that lets users save their files online for accessing them anywhere. By installing the Google Drive Sync app on your Turbo vNAS you can select a shared folder to synchronize data with Google Drive or simply use Google Drive as a backup destination.





Dropbox App

The Dropbox service is a cloud-based storage service that allows you to access your photos, documents, and videos anywhere, anytime with easy sharing. The free space from the Dropbox service is limited however, and to make it more efficient you can connect it with your Turbo vNAS to store files.



How to use the Dropbox App?

The QNAP Dropbox app can synchronize your Dropbox account and your Dropbox folder on the Turbo vNAS in both directions and in real-time. After you install the Dropbox QPKG and log into your Dropbox account, a Turbo vNAS folder called "home" will be created and the synchronization process will start. With Real Time Remote Replication (RTRR), a built-in Turbo vNAS function, you can easily back up files from your Dropbox account.

The following multimedia applications are disabled by default on the TVS-x63+ series to conserve system resources. To enable them, go to "Control Panel" > "General Settings" > "System Administration".



Video Station

Build a corporate video website

Video Station is great for archiving and playing video collections online. Just upload videos, and the Video Station will smoothly play the video with an optimized resolution for your device and bandwidth.

Easy video sorting

You can easily categorize your videos as company videos, movies, TV shows, and music videos for greater organization.

Smart collection

Create a smart video collection that matches predefined criteria for names and ratings, making it easier to find the videos you want to watch.

Easy video sharing

Share your videos with friends & family via email, download link or social networking sites including Facebook, Google+ and Twitter.



App Center & Development Platform



▪ Music Station

Organize huge music collections

Browse your music in multiple ways, create up to 200 playlists, and rate your music to feature it in a "My Favorites" collection.

Cloud music center

Access the Music Station via the Internet to enjoy your entire music collection from anywhere on any device.

Listen to thousands of Internet radio stations

With the built-in Tuneln radio, you can listen to thousands of local and global online radio programs. You can also manually add new radio stations.

Direct audio output

Turn your Turbo vNAS into a complete music system by connecting USB speakers, sound card or DAC for direct audio output.



The free Qmusic mobile app allows you to listen to your complete music collection anytime and anywhere. Scan the QR Code to download!



▪ Photo Station

Centralized management

All of your photos, including RAW photos, can be centrally managed with the Photo Station.

Photo captions

Adding captions for photos can aid in search. For example, you can manually add a created date for selected photos without dates to be able to see them on your timeline of photos.

Review photos on Google Maps

Retrace the steps of your photos by geo-tagging them and creating a map of your photo albums in Google Maps.

Private collection

Create a protected private collection of personal photos & videos that can only be accessed by you.

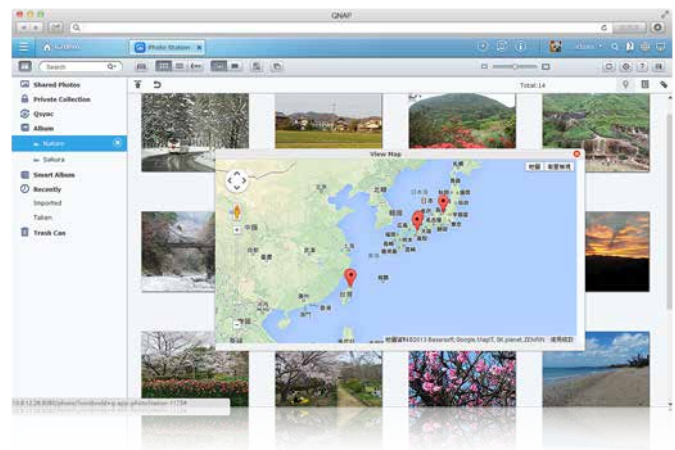

Play by slideshows

Create attractive slideshows using photos and music stored on your Turbo vNAS.

Group photo sharing

Share photos in groups by saving them in Team Folders in your Qsync folder, allowing people with access rights to the Team Folders to browse those photos in their Photo Station.



▪ Download Station

Your 24/7 download center

Once you finish managing download tasks, just turn off your computer and they will keep downloading until they are finished.

Powerful BT search engine

Easily find and add files to your download list with the built-in search engine.

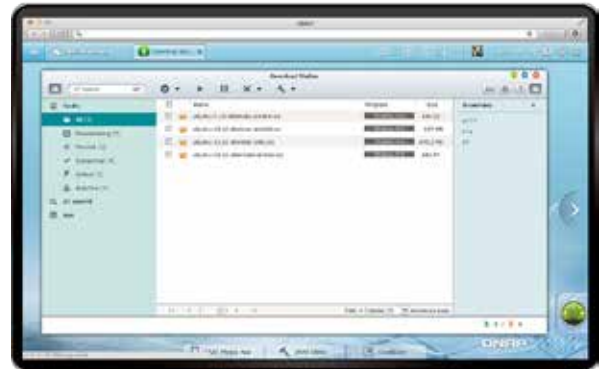

Wide range of supported downloads

Supports downloading from BT, PT, Magnet, FTP/FTPS, HTTP/HTTPS and RSS.

▪ Third-party Development Platform

With its open-source Linux kernel, QTS is a friendly development platform that allows software developers to create all kinds of applications. Developers can also enjoy a more efficient R&D process with the backup, security, cloud storage tools, and reliable Turbo vNAS hardware design.

Dedicated customer service, sales and R&D support

QNAP Turbo vNAS applications can be developed using the following three approaches :

Development Toolkit (API & SDK) :

Developers can use the QNAP Development Toolkit (API & SDK) to design applications that run on client devices (such as smartphones and PCs) to remotely manage and access files stored on their Turbo vNAS.

NAS app development : Depending on your OS needs, you can use VM integration to install an alternative OS to run non-Linux-based applications on the Turbo vNAS.

VM integration : Depending on your OS needs, you can use VM integration to install an alternative OS to run non-Linux-based applications on the Turbo vNAS.

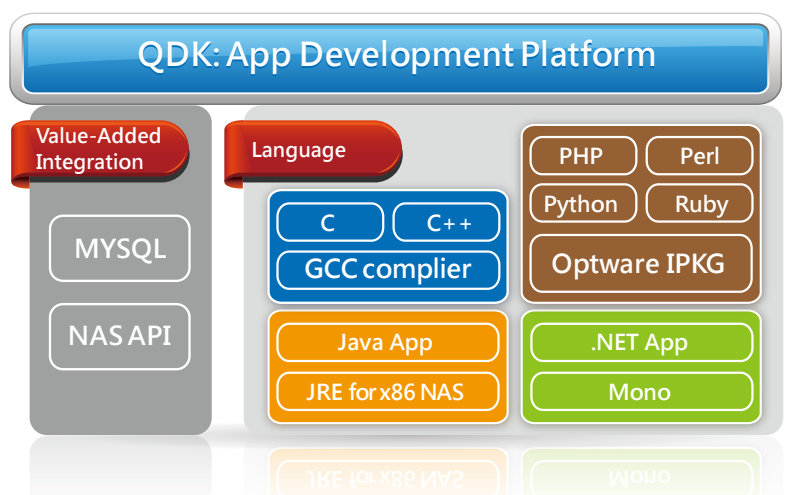

Hardware Specifications



	TVS-463-4G / TVS-463-8G	TVS-663-4G / TVS-663-8G	TVS-863-4G / TVS-863-8G	TVS-863+-8G / TVS-863+-16G
Processor	AMD G-Series quad-core 2.4 GHz with Radeon™ graphics			
Memory (RAM)	TVS-463-4G / TVS-663-4G / TVS-863-4G : 4 GB TVS-463-8G / TVS-663-8G / TVS-863-8G : 8 GB			TVS-863+-8G : 8 GB TVS-863+-16G : 16 GB
Flash	SO-DIMM DDR3L-1600			
Number of RAM Slots	2 (Max 16 GB)			
Max. Number of HDDs/SSDs	4	6	8	
HDDs/SSDs Formfactor, Interface	2.5" or 3.5" SATA 6Gb/s, 3Gb/s; hot-swappable, with keylock			
Expansion Enclosure Support	2 (UX-800P / UX-500P)			
Gigabit LAN Ports	2 (Onboard : 2, expandable to max 4 ports via PCIe NIC)			
10GbE	Yes (Optional with PCIe NIC)			Yes (1 port)
USB 3.0 Ports	5			
Expansion Slot (PCIe)	1			1 (Pre-installed with a 10GbE NIC)
IR Sensor	Yes (QNAP RM-IR002 remote control)			
HDMI	2 (Mirrored Display)			
LED Indicators	Power, Status, LAN, USB, HDD1-4	Power, Status, LAN, USB, HDD1-6	Power, Status, LAN, USB, HDD1-8	
LCD with Buttons	Yes			
Buttons	Power, Reset, USB Auto Copy			
Dimensions (HxWxD)	177.0 x 180.0 x 235.0 mm 6.97 x 7.09 x 9.25 inch	185.0 x 260.2 x 235.5 mm 7.28 x 10.24 x 9.27 inch	185.2 x 298.2 x 235.4 mm 7.29 x 11.74 x 9.27 inch	
Weight (Net/Gross)	185.2 x 298.2 x 235.4 mm 7.29 x 11.74 x 9.27 inch	6.18 / 6.90 kg 13.62 / 15.21 lb	7.83 / 8.90 kg 17.26 / 19.62 lb	
Temperature and Humidity	0-40°C, 5-95% R. H.			
Power Supply Specification	ATX 250W, 100-240V AC, 50-60Hz, 5A			
Power Consumption (W)				
HDD Sleep	34.77	41.56	46.21	48.21
Typical Operation	50.38	58.81	70.45	77.60
S3 Sleep	2.26	2.19	2.35	2.84
RAID Type	Single Disk, RAID 0, RAID 1, RAID 5, RAID 6, RAID 10, RAID 5 + Spare, JBOD	Single Disk, RAID 0, RAID 1, RAID 5, RAID 6, RAID 10, RAID 5/6/10 + Spare, JBOD		
USB One-Touch-Copy Backup	Yes			
Virtualization Station	Yes			
VPN Server (PPTP + OpenVPN)	Yes (PPTP : 15; OpenVPN : 15)			
Surveillance Station				
Default IP Cameras	4			
Max IP Cameras	40 (optional license purchase)			
File Sharing Capability				
Max Users	4096			
Max User Groups	512			
Max Shared Folders	512			
Max Concurrent Connections	1000			

Accessories

	Item	Order P/N	Description
Expansion Enclosure		UX-800P	8-bay USB 3.0 storage expansion enclosure; SATA 6Gb/s; 185.2 x 298.2 x 235.4 mm / 7.29 x 11.74 x 9.27 inch (H x W x D)
		UX-500P	5-bay USB 3.0 storage expansion enclosure; SATA 6Gb/s; 185.2 x 210.6 x 235.4 mm / 7.29 x 8.29 x 9.27 inch (H x W x D)
RAM		RAM-2GDR3L-SO-1600	2GB DDR3L-1600 SODIMM RAM module
		RAM-4GDR3L-SO-1600	4GB DDR3L-1600 SODIMM RAM module
		RAM-8GDR3L-SO-1600	8GB DDR3L-1600 SODIMM RAM module
LAN Card		LAN-10G1T-D	QNAP single-port 10 Gigabit 10GBASE-T network expansion card
		LAN-10G1SR	QNAP single-port 10 Gigabit SFP+ network expansion card
		LAN-10G2T-D	QNAP dual-port 10 Gigabit 10GBASE-T network expansion card
		LAN-1G2T-D	QNAP dual-port Gigabit network expansion card
Remote Control		RM-IR002	QNAP infrared(IR) remote control

Software Specifications

Operating System

- QTS 4.1 (embedded Linux)

Supported Client OS

- Windows® XP, Vista, Windows® 7 (32/64-bit), Windows® 8 (32/64-bit), Windows® Server 2003/2008 R2/2012
- Apple Mac OS X
- Linux & UNIX

Supported Browsers

- Microsoft Internet Explorer 10+
- Mozilla Firefox 8+
- Apple Safari 4+
- Google Chrome

Multilingual Support

- Chinese (Traditional & Simplified), Czech, Danish, Dutch, English, Finnish, French, German, Greek, Hungarian, Italian, Japanese, Korean, Norwegian, Polish, Portuguese (Brazil), Romanian, Russian, Spanish, Swedish, Thai, Turkish

File System

- Internal Hard Drive : EXT4
- External Hard Drive : EXT3, EXT4, NTFS, FAT32, HFS+

Networking

- TCP/IP (IPv4 & IPv6 : Dual Stack)
- Dual Gigabit NICs with jumbo frame (failover, multi-IP settings, port trunking/ NIC teaming)
- Service binding based on network interfaces
- Proxy server (Squid available in App Center)
- Proxy client
- DHCP client, DHCP server
- Protocols : CIFS/SMB, AFP (v3.3), NFS(v3), FTP, FTPS, SFTP, TFTP, HTTP(S), Telnet, SSH, iSCSI, SNMP, SMTP, and SMSC
- UPnP & Bonjour Discovery
- USB Wi-Fi 802.11ac adapter support

Not all IPv6 services are supported.

Security

- Network access protection with auto-blocking : SSH, Telnet, HTTP(S), FTP, CIFS/SMB, AFP
- CIFS host access control for shared folders
- FIPS 140-2 validated AES 256-bit volume-based data encryption*
- AES 256-bit external drive encryption*
- Importable SSL certificates
- Instant alert via email, SMS, beep, and LCD panel

Storage Management

- QNAP flexible Volume/LUN with thin provisioning and space reclaim
- RAID 0,1, 5, 6, 10, 5/6/10+ hot spares**
- Supports storage pool
- Online volume expansion
- Online storage pool expansion
- Online RAID capacity expansion and online RAID level migration
- SMART data migration
- Storage expansion via QNAP UX-500P/UX-800P expansion units
- Bad block scan and hard drive S.M.A.R.T.
- Bad block recovery
- RAID recovery
- Bitmap support

Power Management

- Wake on LAN
- Internal hard drive standby mode
- Scheduled power on/off
- Automatic power on after power recovery
- USB and network UPS support with SNMP management
- System sleep mode (S3)

Access Right Management

- Batch users creation
- Import/Export users
- User quota management
- Local user access control for CIFS, AFP, FTP, and WebDAV
- Application access control for Photo

Station, Music Station, Video Station, and File Station

- Subfolder permissions support for CIFS/SMB, AFP, FTP, and File Station

Domain Authentication Integration

- Microsoft Active Directory (AD) & Domain Controller support
- LDAP server, LDAP client
- Domain users login via CIFS/SMB, AFP, FTP, and File Station

myQNAPcloud Service

- Private cloud storage and sharing
- Free host name registration (DDNS)
- Auto router configuration (via UPnP)
- Web-based file manager with HTTPS 2048-bit encryption
- CloudLink for remote access without complicated router setup
- myQNAPcloud connect for easy VPN connection (Windows® VPN utility)

Qsync

- Syncs files among multiple devices with SSL support
- Selective synchronization for syncing specific folders only
- Share team folder as a file center for team collaboration (Maximum sync tasks : 32)
- Shares files by links via email
- Policy settings for conflicted files and file type filter support
- Version control : up to 64 versions.
- Incremental synchronization for HDD space saving
- Supports Windows® & Mac OS

Web Administration

- Multi-window, multi-tasking based system management
- Smart toolbar and dashboard for neat system status display
- Dynamic DNS (DDNS)
- SNMP (v2 & v3)
- Resource monitor
- Network recycle bin for file deletion via CIFS/SMB, AFP, and File Station
- Automatic cleanup
- File type filter
- Comprehensive logs (events & connection)
- Syslog client/server
- System settings backup and restore
- Mobile app : Qmanager for remote system monitoring & management

File Server

- File sharing across Windows®, Mac, and Linux/UNIX
- Windows® ACL
- Advanced folder permission for CIFS/SMB, AFP, FTP
- Shared folder aggregation (CIFS/SMB)

FTP Server

- FTP over SSL/TLS (Explicit)
- FXP support
- Passive ftp port range control

File Station

- Supports ISO Mounting (Up to 256 ISO Files)
- Supports thumbnail display of multimedia files
- Supports sharing download links and upload links
- Drag-n-drop files via Google Chrome and Mozilla Firefox
- Photo, music, and video preview and playback with hardware-accelerated transcoding
- File compression (ZIP or 7z)
- Creation of and sending download links for sharing public files with expiration time and password protection
- Support for displaying subtitles (.SRT, UTF-8 format)
- Video seeking support for video playback during on-the-fly transcoding
- Support slideshow playback in media viewer
- Mobile App : Qfile for file browsing and management

Backup Station

- Remote replication server (over rsync)
- Real-time remote replication (RTRR) to another QNAP NAS or FTP server
- Works as both RTRR server & client with bandwidth control
- Real-time & scheduled backup
- Encryption, compression, file filters, and transfer rate limitations
- Encrypted replication between QNAP NAS servers
- Desktop backup with QNAP NetBak Replicator for Windows®
- Apple Time Machine backup support
- Data backup to multiple external storage devices
- Synchronizes with cloud storage : Amazon S3, ElephantDrive, Symform, Dropbox, and Google Drive
- Third party backup software support : Veeam backup & replication, Acronis True Image, Arcserve backup, emc retrospect, Symantec Backup Exec, etc.

Cloud Backup Station

- Amazon S3
- Amazon Glacier
- Webdev-based cloud storage
- Microsoft Azure
- Open Stack

Storage Plug & Connect

- Creating and mapping shared folders using QNAP Windows® Qfinder
- Creation of and connection to iSCSI targets/LUN

iSCSI (IP SAN)

- iSCSI target with multi-LUNs per target (Up to 256 targets/LUNs combined)
- Support for LUN mapping & masking
- Online LUN capacity expansion
- Support for SPC-3 persistent reservation
- Support for MPIO & MC/S
- iSCSI LUN backup, one-time snapshot, and restoration
- iSCSI connection and management by QNAP Windows® Qfinder
- Virtual disk drive (via iSCSI initiator)
- Stack chaining master
- Max No. of virtual disk drives : 8

Virtualization Station

- Supports creating one Virtual Machine (VM) to run an operating system such as Windows®, Linux, Unix, and Android
- VM import from Virtual Appliances
- VM export into a virtual appliance in OVF / QVM format
- VM clone
- VM snapshot
- HTML5-based shared remote console

Surveillance Station

- Supports over 2,700 IP cameras
- Includes 4 free camera licenses, up to 40 camera channels via additional license purchase
- Instant playback to check recent events
- Online editing to change cameras when in live view
- Visual aid by using e-maps
- Playback and speed control by shuttle bar
- Video preview using playback timeline
- Intelligent Video Analytics (IVA) for advanced video search
- Surveillance client for Mac
- Mobile surveillance app : Vmobile (iOS and Android)
- Mobile recording app : Vcam (iOS and Android)

VPN Server

- Secure remote access : PPTP & OpenVPN VPN services
- Max number of clients : 30

VPN Client

- Supported VPN protocols : PPTP & OpenVPN services
- PPTP authentication : PAP, CHAP, MS-CHAP, MS-CHAPv2
- PPTP encryption : None, AES 40/128 bit, AES 256 bit

- OpenVPN encryption : None, AES 40/128 bit, AES 256 bit
- Transmission package monitor
- OpenVPN port control
- OpenVPN link compression

HD (HybridDesk) Station

- Playback videos, music, photos on you TV with XBMC via HDMI output
- Watch various online contents such as YouTube, Flickr, Picasa, Shoutcast, and more.
- Web browser (Chrome, Firefox)
- Supports USB keyboard and mouse
- Supports QNAP Qremote app and the official XBMC remote app
- Supports user login permissions

Note :

- The playback and quality of some video files may be affected due to the CPU and GPU decoding abilities.
- Up to 7.1 channel audio passthrough is supported

Transcode Management

- Transcode 1080p video files to 240p, 360p, 480p, and 720p resolutions
- Automatic video transcoding for watched folders
- Hardware-accelerated transcoding support
- Embed subtitles with videos in background transcoding

Print Server

- Max. number of printers : 3
- Support for Internet Printing Protocol
- Print job display and management
- IP-based and domain name-based privilege control

iTunes Server

- Audio and video sharing for Windows® & Mac iTunes

AirPlay & Chromecast

- Streams videos, photos and music from the NAS to Apple TV via Qfile or QAirPlay&Chromecast's web-based controller
- Streams videos, photos and music from the NAS to TV with a Chromecast dongle via Qfile , Qvideo or QAirPlay&Chromecast's web-based controller

DLNA Server

- Supports DLNA/UPnP TVs and players such as PlayStation 3 and Xbox 360
- Supported audio formats : AIFF, APE, DSD (DSF, DFF), FLAC, M4A, M4A Apple Lossless (ALAC), MP3, Ogg Vorbis, WAV (PCM, LPCM), WMA, WMA PRO, WMA VBR*
- Support CUE indexing files for APE, FLAC audio format.
- Video and audio on-the-fly transcoding

*DRM-protected files are not supported.

App Center

- Over 100 official and community software add-ons such as Photo Station, Music Station, Video Station, Download Station, Signage Station, Notes Station, Digital TV Station and HappyGet.

* Somedata encryption functions may not available in accordance with the legislative restrictions of some countries.

** This feature may vary according to different models.

Designs and specifications are subject to change without notice.

Turbo vNAS The Golden Cloud Series

TVS-x63+ Series

QNAP

10GbE Turbo vNAS with Cutting-edge Features for Cost-conscious Applications

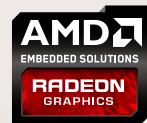

HDMI

TVS-863+



TVS-463

TVS-663

TVS-863

QNAP Systems, Inc.

TEL : +886-2-2641-2000 FAX : +886-2-2641-0555 Email: qnapsales@qnap.com
Address : 3F, No.22, Zhongxing Rd., Xizhi Dist., New Taipei City, 221, Taiwan

QNAP may make changes to specification and product descriptions at any time, without notice.
Copyright © 2015 QNAP Systems, Inc. All rights reserved.

QNAP® and other names of QNAP Products are proprietary marks or registered trademarks of QNAP Systems, Inc. Other products and company names mentioned herein are trademarks of their respective holders.

AMD, the AMD logo, and combinations thereof are trademarks of Advanced Micro Devices, Inc.

Netherlands (Warehouse Services)

Email : nlsales@qnap.com
TEL : +31(0)107600830

Germany

Email : desales@qnap.com
TEL : +49-89-381562991

China

Email : cnsales@qnap.com.cn
TEL : +86-400-628-0079

India

Email : indiasales@qnap.com

US

Email : usasales@qnap.com
TEL : +1-909-595-2782

Thailand

Email : thsales@qnap.com
TEL : +66-2-5415988



P/N: 51000-023756-RS
201501 (EN) B